



198 Kezhu Road, Sciencetech Park, Guangzhou Economic & Technological Development District, Guangzhou, China 510663
Telephone: +86 (0) 20 82155555
Fax: +86 (0) 20 82075059
Email: ee.guangzhou@sgs.com

Report No.: GZEM120800354101
Page: 1 of 54

TEST REPORT

Application No:	GZEM1208003541HS
Applicant:	HoMedics Group Ltd
Product Name:	Fat reduce, weight loss
Product Description:	Fat reduce, weight loss
Model No:	USL-1000-EU
P.O. No.:	PC0001156
Standards:	EN 55011:2009+A1:2010, EN 55014-2:1997+A1:2001+A2:2008, EN 61000-3-2:2006+A1:2009+A2:2009, EN 61000-3-3:2008.
Date of Receipt:	2012-08-24
Date of Test:	2012-08-31 to 2012-09-14
Date of Issue:	2012-11-28
Test Result:	Pass*

* In the configuration tested, the EUT complied with the standards specified above.

The CE mark as shown below can be used, under the responsibility of the manufacturer, after completion of an EC Declaration of Conformity and compliance with all relevant EC Directives.



Richard Li
Manager



The manufacturer should ensure that all products in series production are in conformity with the product sample detailed in this report. If the product in this report is used in any configuration other than that detailed in the report, the manufacturer must ensure the new system complies with all relevant standards.

The report must not be used by the client to claim product certification, approval, or endorsement by NVLAP, NIST, or any agency of the federal government. All test results in this report can be traceable to National or International Standards.

This document is issued by the Company subject to its General Conditions of Service printed overleaf, available on request or accessible at www.sgs.com/terms_and_conditions.htm and, for electronic format documents, subject to Terms and Conditions for Electronic Documents at www.sgs.com/terms_e-document.htm. Attention is drawn to the limitation of liability, indemnification and jurisdiction issues defined therein. Any holder of this document is advised that information contained hereon reflects the Company's findings at the time of its intervention only and within the limits of Client's instructions, if any. The Company's sole responsibility is to its Client and this document does not exonerate parties to a transaction from exercising all their rights and obligations under the transaction documents. This document cannot be reproduced except in full, without prior written approval of the Company. Any unauthorized alteration, forgery or falsification of the content or appearance of this document is unlawful and offenders may be prosecuted to the fullest extent of the law. Unless otherwise stated the results shown in this test report refer only to the sample(s) tested and such sample(s) are retained for 90 days only.

2 Version

Revision Record				
Version	Chapter	Date	Modifier	Remark
00		2012-11-28		Original

Authorized for issue by:			
Tested By			2012-08-31 to 2012-09-14 <hr/> Date
Prepared By			2012-11-28 <hr/> Date
Checked By			2012-11-28 <hr/> Date

3 Test Summary

Electromagnetic Interference (EMI)				
Test	Test Requirement	Test Method	Class / Severity	Result
Conducted Emission (150 kHz to 30 MHz)	EN 55011:2009 +A1:2010	EN 55011:2009 +A1:2010	Table 3	PASS①
Radiated Emission (30 MHz to 1 GHz)	EN 55011:2009 +A1:2010	EN 55011:2009 +A1:2010	Table 5	PASS②
Harmonic Emission on AC	EN 61000-3-2:2006 +A1:2009+A2:2009	EN 61000-3-2:2006 +A1:2009+A2:2009	Class A	PASS**
Flicker Emission on AC	EN 61000-3-3:2008	EN 61000-3-3:2008	Clause 5 of EN 61000-3-3	PASS
Electromagnetic Susceptibility(EMS)				
Test	Test Requirement	Test Method	Class / Severity	Result
Electrostatic Discharge (ESD)	EN 55014-2:1997 +A1:2001+A2:2008	EN 61000-4-2:2009	Contact ±4 kV Air ±8 kV	PASS
Electrical Fast Transients (EFT) on AC	EN 55014-2:1997 +A1:2001+A2:2008	EN 61000-4-4:2004 +A1:2010	± 0.5 kV ± 1.0kV	PASS
Surge Immunity on AC	EN 55014-2:1997 +A1:2001+A2:2008	EN 61000-4-5:2006	±1 kV D.M.†	PASS③
Injected Currents on AC (150 kHz to 230 MHz)	EN 55014-2:1997 +A1:2001+A2:2008	EN 61000-4-6:2009	3V r.m.s (emf), 80%, 1kHz Amp. Mod.	PASS
Voltage Dips and Interruptions on AC	EN 55014-2:1997 +A1:2001+A2:2008	EN 61000-4-11:2004	0 % U_T^* for 0.5 per 40 % U_T^* for 10 per 70 % U_T^* for 25 per	PASS
Remark :				
* U_T is the nominal supply voltage				
† D.M. – Differential Mode				
**: Please refer to Section 7.3 of this report for details.				
The EUT is classified as Group 1, Class B equipment according to the standard.				

Group 1 equipment: group 1 contains all equipment in the scope of this standard which is not classified as group 2 equipment.

Group 2 equipment: group 2 contains all ISM RF equipment in which radio-frequency energy in the frequency range 9 kHz to 400 GHz is intentionally generated and used or only used, in the form of electromagnetic radiation, inductive and/or capacitive coupling, for the treatment of material or inspection/analysis purposes.

Class A equipment is equipment suitable for use in all establishments other than domestic and those directly connected to a low voltage power supply network which supplies buildings used for domestic purposes.

Class A equipment shall meet class A limits.

Warning: Class A equipment is intended for use in an industrial environment. In the documentation for the user, a statement shall be included drawing attention to the fact that there may be potential difficulties in ensuring electromagnetic compatibility in other environments, due to conducted as well as radiated disturbances.

Class B equipment is equipment suitable for use in domestic establishments and in establishments directly connected to a low voltage power supply network which supplies buildings used for domestic purposes.

Class B equipment shall meet class B limits.

① ② ③: The EUT passed the Conducted Emission, Radiated Emission and Surge Immunity tests after modifications:

Conducted Emission

1. Delete one inductor T3 as the following figure shown.
2. Delete two capacitors C11 and C15 as the following figure shown.

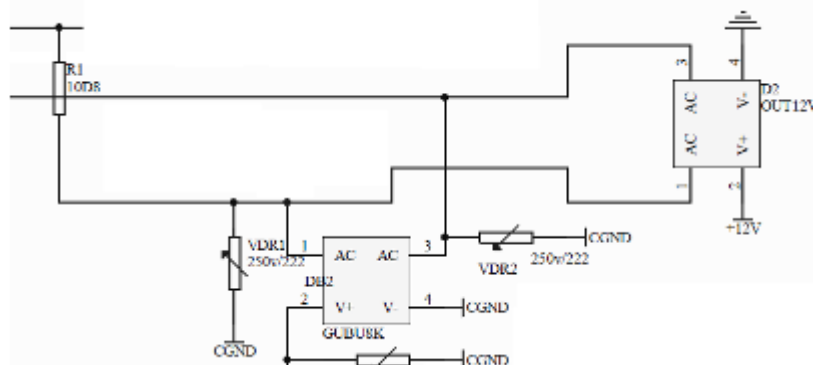

3. Add one inductor LN1 with new one which inductance is 64mH as the following figure shown.
4. Add one capacitor CX1 which capacitance is 0.22uF/275V as the following figure shown.
5. Add one capacitor CX2 which capacitance is 0.1uF/275V as the following figure shown.

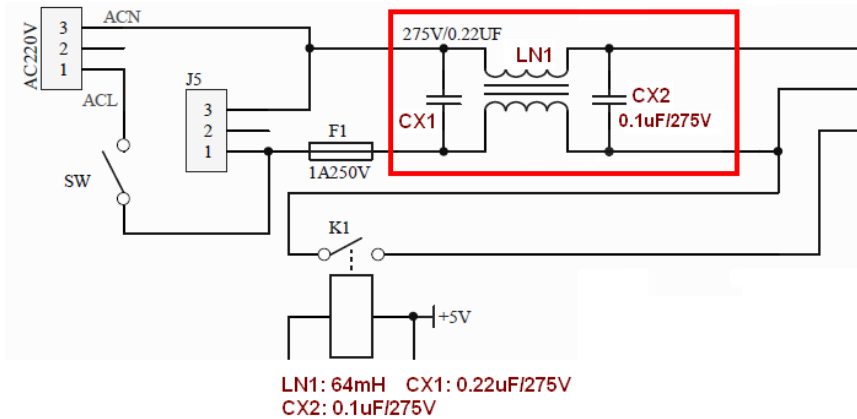

6. Add one capacitor CN1 which capacitance is 103/2kV as the following figure shown.
7. Add one capacitor CN2 which capacitance is 221/1kV as the following figure shown.

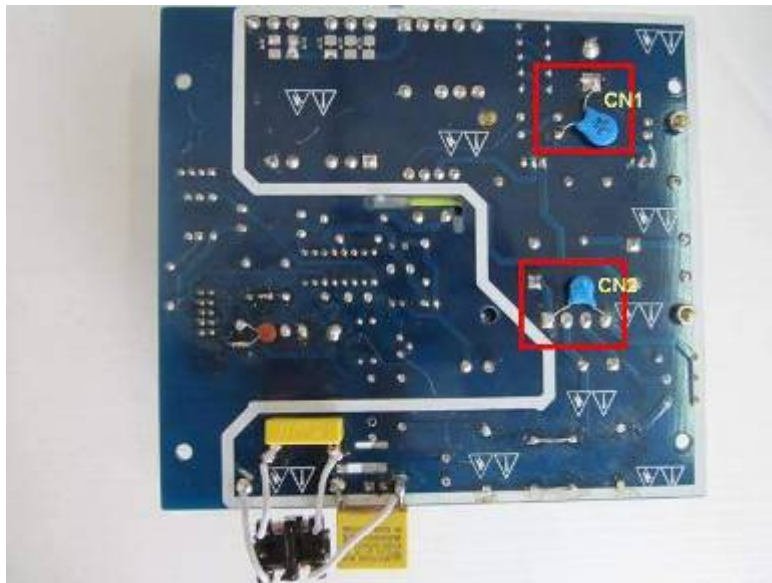

Radiated Emission

- 8. Add one capacitor CN3 which capacitance is 0.1uF as the following figure shown.
- 9. Add one ferrite bead FB1 as the following figure shown.

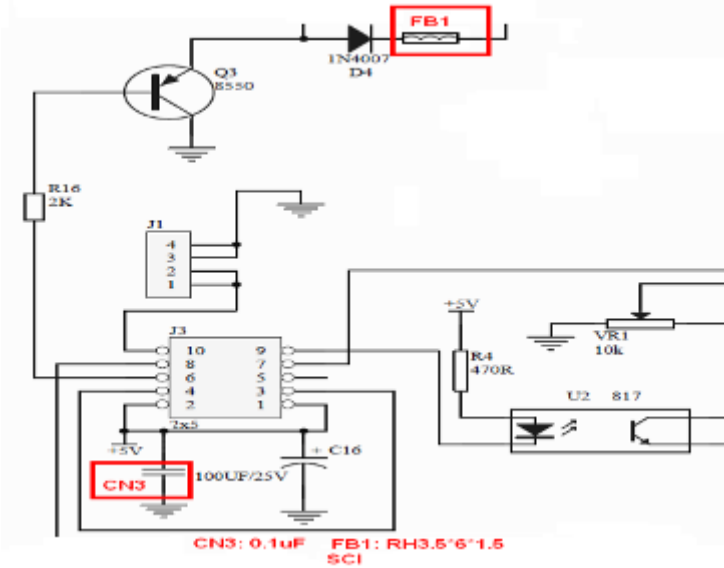

- 10. Add one capacitor CN4 which capacitance is 0.1uF as the following figure shown.
- 11. Add one capacitor CN5 which capacitance is 0.1uF as the following figure shown.
- 12. Add one capacitor CN6 which capacitance is 0.1uF as the following figure shown.

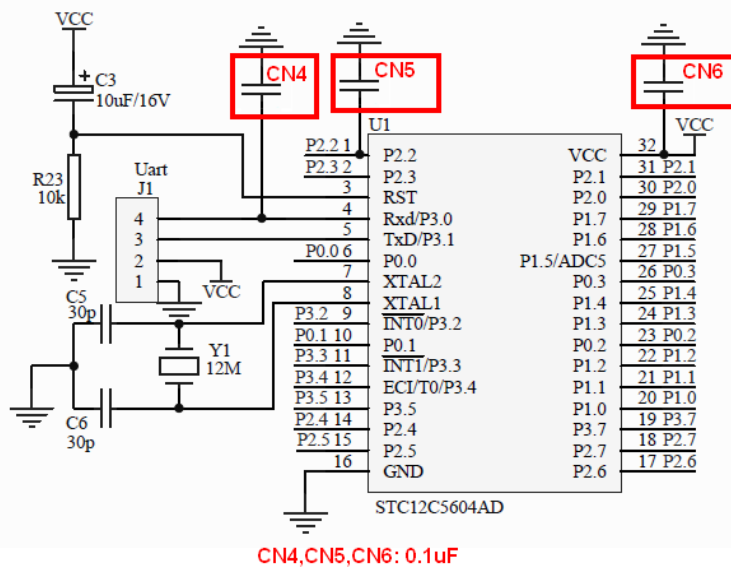

13. Add one ferrite core for cable which is twisted one circle as the following photo shown.

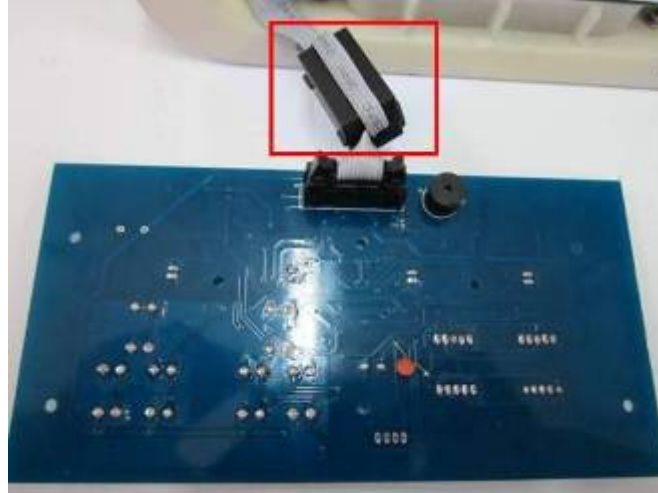

Ferrite Core Model No.: UF-65B
SCI

14. Add one ferrite core for the AC power cable which is twisted six circles as the following photo shown.

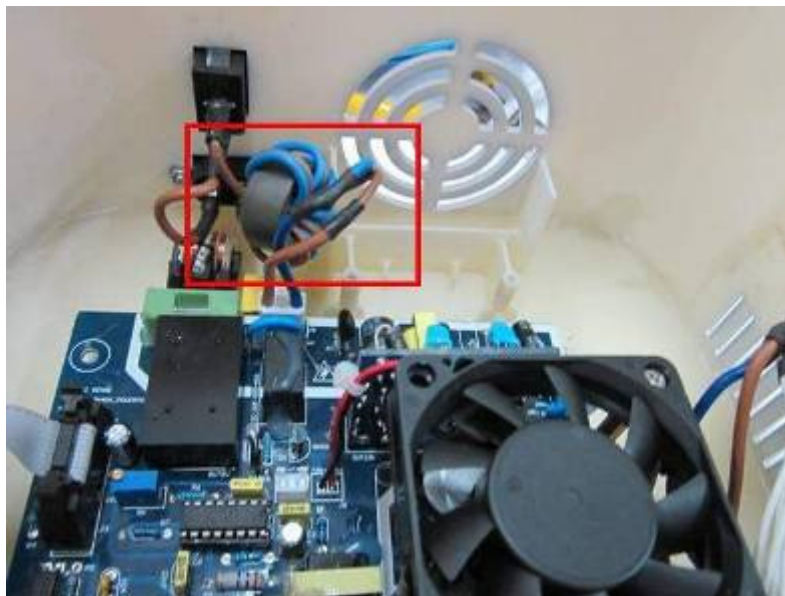

Ferrite Core Model No.: T25*12*15
SCI

Surge

15. Add one voltage-dependent RZ1 as the following figure shown.



RZ1: 14D471K



4 Contents

1	COVER PAGE	1
2	VERSION	2
3	TEST SUMMARY	3
4	CONTENTS	9
5	GENERAL INFORMATION	11
5.1	Client Information	11
5.2	General Description of E.U.T.....	11
5.3	Details of E.U.T.....	11
5.4	Description of Support Units.....	11
5.5	Deviation from Standards	11
5.6	General Test Climate During Testing.....	11
5.7	Abnormalities from Standard Conditions.....	11
5.8	Monitoring of EUT for All Immunity Test	11
5.9	Test Location	11
5.10	Test Facility	13
6	EQUIPMENT USED DURING TEST.....	14
7	ELECTROMAGNETIC INTERFERENCE TEST RESULTS	17
7.1	Conducted Emissions on Mains Terminals, 150 kHz to 30MHz	17
7.2	Radiated Emissions, 30 MHz to 1 GHz.....	21
7.3	Harmonics Test Result.....	25
7.4	Flicker Test Result	26
8	ELECTROMAGNETIC SUSCEPTIBILITY TEST RESULTS	29
8.1	Performance Criteria Description in Clause 6 of EN 55014-2	29
8.2	ESD	30
8.3	Electrical Fast Transients (EFT)	33
8.4	Surge	35
8.5	Conducted Immunity 0.15 MHz to 230 MHz	38
8.6	Voltage Dips and Interruptions	41
9	PHOTOGRAPHS	44
9.1	Conducted Emissions on Mains Terminals Test Setup	44
9.2	Radiated Emission Test Setup	45
9.3	Flicker Test Setup	46



9.4	ESD Test Setup	47
9.5	EFT, Surge, Voltage Dip and Interruptions Test Setup.....	48
9.6	Conducted Immunity Test Setup	49
9.7	EUT Constructional Details	50

5 General Information

5.1 Client Information

Applicant: HoMedics Group Ltd
Address of Applicant: HoMedics House, Somerhill Business Park, Five Oak Green Road,
Tonbridge, Kent TN11 0GP England

5.2 General Description of E.U.T.

Product Name: Fat reduce, weight loss
Product Description: Fat reduce, weight loss
Model No.: USL-1000-EU

5.3 Details of E.U.T.

Rated Supply (Voltage): AC 220-240V 50Hz 30W
Power Cable: 1.8m x 2 wires unscreened AC mains cable.

5.4 Description of Support Units

The EUT has been tested with water as load.

5.5 Deviation from Standards

All Immunity tests to EN 55014-2 were performed in accordance with EN 61000-4-x and not IEC 61000-4-x. (x=2, 4, 5, 6, 11).

5.6 General Test Climate During Testing

Temperature: 15-30 °C Humidity: 30-70 %RH Atmospheric Pressure: 860-1060 mbar

5.7 Abnormalities from Standard Conditions

The EUT passed the Conducted Emission, Radiated Emission and Surge Immunity tests after modifications.

5.8 Monitoring of EUT for All Immunity Test

Audio: N/A
Visual: LED Lighting and LCD display of the EUT

5.9 Test Location

All tests were performed at:
SGS-CSTC Standards Technical Services Co., Ltd., Guangzhou EMC Laboratory,
198 Kezhu Road, Scientech Park, Guangzhou Economic & Technology Development District,
Guangzhou, China 510663
Tel: +86 20 82155555 Fax: +86 20 82075059



No tests were sub-contracted.

5.10 Test Facility

The test facility is recognized, certified, or accredited by the following organizations:

- **NVLAP (Lab Code: 200611-0)**

SGS-CSTC Standards Technical Services Co., Ltd., Guangzhou EMC Laboratory is recognized under the National Voluntary Laboratory Accreditation Program (NVLAP/NIST). NVLAP Code: 200611-0.

- **ACMA**

SGS-CSTC Standards Technical Services Co., Ltd., EMC Laboratory can also perform testing for the Australian C-Tick mark as a result of our NVLAP accreditation.

- **SGS UK (Certificate No.: 32), SGS-TUV SAARLAND and SGS-FIMKO**

Have approved SGS-CSTC Standards Technical Services Co., Ltd., EMC Laboratory as a supplier of EMC TESTING SERVICES and SAFETY TESTING SERVICES.

- **CNAS (Lab Code: L0167)**

SGS-CSTC Standards Technical Services Co., Ltd., EMC Laboratory has been assessed and in compliance with CNAS-CL01:2006 accreditation criteria for testing laboratories (identical to ISO/IEC 17025:2005 General Requirements) for the Competence of Testing Laboratories.

- **FCC (Registration No.: 282399)**

SGS-CSTC Standards Technical Services Co., Ltd., EMC Laboratory has been registered and fully described in a report filed with the (FCC) Federal Communications Commission. The acceptance letter from the FCC is maintained in our files. Registration 282399, May 31, 2002.

- **Industry Canada (Registration No.: 4620B-1)**

The 3m/10m Alternate Semi-anechoic chamber of SGS-CSTC Standards Technical Services Co., Ltd. has been registered by Certification and Engineering of Industry Canada for radio equipment testing with Registration No. 4620B-1.

- **VCCI (Registration No.: R-2460, C-2584, G-449 and T-1179)**

The 10m Semi-anechoic chamber and Shielded Room of SGS-CSTC Standards Technical Services Co., Ltd. have been registered in accordance with the Regulations for Voluntary Control Measures with Registration No.: R-2460, C-2584, G-449 and T-1179 respectively.

- **CBTL (Lab Code: TL129)**

SGS-CSTC Standards Technical Services Co., Ltd., E&E Laboratory has been assessed and fully comply with the requirements of ISO/IEC 17025:2005, the Basic Rules, IEC 61010-1:2006-10 and Rules of procedure IEC 61010-2:2006-10, and the relevant IEC 61010-2:2006-10 Operational documents.

6 Equipment Used during Test

Conducted Emission						
No.	Test Equipment	Manufacturer	Model No.	Serial No.	Cal.Due date	Calibration Interval
					(YYYY-MM-DD)	
EMC0306	Shielding Room	Zhong Yu	8 x 3 x 3.8 m ³	N/A	N/A	N/A
EMC0118	Two-line v-netwok	R&S	ENV216	100359	2013-03-12	1Y
EMC0102	LISN	SCHAFFNER CHASE	MN2050D/1	1421	2013-9-6	1Y
EMC2046	Artificial Mains Network (LISN)	AFJ Instruments	LT32C	S.N.320311201 50	2013-03-12	1Y
EMC0506	EMI Test Receiver	Rohde & Schwarz	ESCS30	100085	2013-03-12	1Y
EMC0107	Coaxial Cable	SGS	2m	N/A	2013-07-10	1Y
EMC0106	Voltage Probe	SGS	N/A	N/A	N/A	1Y
EMC0120	8 Line ISN	Fischer Custom Communications Inc.	FCC-TLISN-T8-02	20550	2013-11-5	1Y
EMC0121	4 Line ISN	Fischer Custom Communications Inc.	FCC-TLISN-T4-02	20549	2013-11-5	1Y
EMC0122	2 Line ISN	Fischer Custom Communications Inc.	FCC-TLISN-T2-02	20548	2013-11-5	1Y
EMC2047	CDN	Elektronik- Feinmechanik	L-801:AF2	2793	2014-11-11	3Y
EMC2048	CDN	Elektronik- Feinmechanik	L-801:M2/M3	2738	2014-11-11	3Y
EMC2062	6dB Attenuator	HP	8491A	24487	2013-01-11	1Y
EMC167	Conical metal housing	SGS-EMC	N/A	N/A	2013-02-16	1Y

RE in Chamber						
No.	Test Equipment	Manufacturer	Model No.	Serial No.	Cal.Due date	Calibration Interval
					(YYYY-MM-DD)	
EMC0525	Compact Semi-Anechoic Chamber	ChangZhou ZhongYu	N/A	N/A	2014-08-30	2Y
EMC0522	EMI Test Receiver	Rohde & Schwarz	ESIB26	100283	2013-06-29	1Y
EMC0056	EMI Test Receiver	Rohde & Schwarz	ESCI	100236	2013-03-12	1Y
EMC0528	RI High frequency Cable	SGS	20 m	N/A	2013-06-01	1Y
EMC2025	Trilog Broadband Antenna 30-3000MHz	SCHWARZBECK MESS-ELEKTRONIK	VULB 9163	9163-450	2013-12-17	2Y
EMC0524	Bi-log Type Antenna	Schaffner -Chase	CBL6112B	2966	2013-11-27	2Y
EMC0519	Bilog Type Antenna	Schaffner -Chase	CBL6143	5070	2013-03-26	2Y
EMC2026	Horn Antenna 1-18GHz	SCHWARZBECK MESS-ELEKTRONIK	BBHA 9120D	9120D-841	2013-11-28	2Y
EMC0518	Horn Antenna	Rohde & Schwarz	HF906	100096	2014-07-01	2Y
EMC0521	1-26.5 GHz Pre-Amplifier	Agilent	8449B	3008A01649	2013-03-12	1Y
EMC0049	Amplifier	Agilent	8447D	2944A10862	2013-03-12	1Y
EMC0075	310N Amplifier	Sonama	310N	272683	2013-03-12	1Y
EMC0523	Active Loop Antenna	EMCO	6502	42963	2014-04-07	2Y
EMC2041	Broad-Band Horn Antenna (14)15-26.5(40)GHz	SCHWARZBECK MESS-ELEKTRONIK	BBHA 9170	9170-375	2014-06-01	3Y
EMC0530	10m Semi-Anechoic Chamber	ETS	N/A	N/A	2014-04-27	2Y

Harmonics / Flicker test						
No.	Test Equipment	Manufacturer	Model No.	Serial No.	Cal.Due date	Calibration Interval
					(YYYY-MM-DD)	
EMC0608	AC Power Source	California	5000ix	56627	2013-03-12	1Y
EMC0607	Power Analyzer	California	PACS	72400	2013-03-12	1Y

Electrostatic Discharge						
No.	Test Equipment	Manufacturer	Model No.	Serial No.	Cal.Due date	Calibration Interval
					(YYYY-MM-DD)	
EMC0809	ESD Simulator	EM Test AG	Dito	V0735102864	2013-11-5	1Y
EMC0804	ESD Ground Plane	SGS	3m x 3m	N/A	N/A	N/A
EMC0078	Temperature, & Humidity	Shanghai Meteorological Instrument factory Co., Ltd.	ZJ1-2B	709131	2013-11-5	1Y

EFT, Surge, Voltage dips and Interruption						
No.	Test Equipment	Manufacturer	Model No.	Serial No.	Cal.Due date	Calibration Interval
					(YYYY-MM-DD)	
EMC2059	Modular Impulse Surge Generator	EMC PARTNER	MIG0603EN	259	2013-06-13	1Y
EMC2060	High speed signal Surge CDN	EMC PARTNER	CDN-UTP	CDN-UTP0089	2013-05-15	1Y
EMC1010	EMC Immunity Test System	Thermo KeyTek	Pro-Plus	501276	2013-03-12	1Y
EMC2012	Power-Electronics Measurement System	Tektronix	TDS 744A	N/A	2013-03-12	1Y

Conducted Immunity						
No.	Test Equipment	Manufacturer	Model No.	Serial No.	Cal.Due date	Calibration Interval
					(YYYY-MM-DD)	
EMC1101	Signal Generator	Rohde & Schwarz	SMY01	825675/016	2013-11-05	1Y
EMC1102	Amplifier 0.15-230MHz	Ophirrf	GRF5048	1003	2013-11-05	1Y
EMC1103	Power Meter	Rohde & Schwarz	NRVS	825770/079	2013-03-12	1Y
EMC0071	URV5-Z2 Insert. Unit	R&S	URV5-Z2	100309	2013-03-12	1Y
EMC1105	Dual Directional coupler	Werlatone Inc.	C1795	6635	2013-11-05	1Y
EMC2012	Oscilloscope	Tektronix	TDS 744A	N/A	2013-03-12	1Y
EMC1108	CDN M3	Schaffner Chase	CDN-M3-16	9866	2014-11-11	3Y
EMC1107	CDN M2	Schaffner Chase	CDN-M2-16	9863	2014-11-11	3Y
EMC1116	Current Probe	Schaffner Chase	CIP9136	1155	2014-11-11	3Y
EMC1117	Current Probe	Schaffner Chase	CSP8445	18	2014-11-11	3Y

General used equipment						
No.	Test Equipment	Manufacturer	Model No.	Serial No.	Cal.Due date	Calibration Interval
					(YYYY-MM-DD)	
EMC0006	DMM	Fluke	73	70681569	2013-11-5	1Y
EMC0007	DMM	Fluke	73	70671122	2013-11-5	1Y

7 Electromagnetic Interference Test Results

7.1 Conducted Emissions on Mains Terminals, 150 kHz to 30MHz

Test Requirement:	EN 55011
Test Method:	EN 55011
Test Date:	2012-08-31 (initial test) 2012-09-10 (test after modification)
Test Voltage	AC 230V 50Hz
Frequency Range:	150 kHz to 30 MHz
Class / Severity:	Group 1, Class B
Detector:	Peak for pre-scan Quasi-Peak and Average for final measurement
Resolution Band Width:	9 KHz (150 kHz to 30 MHz)
Limit:	Table 3 of EN 55011

Frequency range MHz	At mains terminals dB (µV)	
	Quasi-peak	Average
0.15 to 0.50	66 to 56	56 to 46
0.5 to 5	56	46
5 to 30	60	50

Note1: The limit decreases linearly with the logarithm of the frequency in the range 0.15 MHz to 0.50 MHz.

Note2: The lower limit is applicable at the transition frequency.

7.1.1 E.U.T. Operation

EUT Operation:	Mode 1: ultrasonic mode with maximum power. Mode 2: ultrasonic mode with medium power. Mode 3: ultrasonic mode with minimum power. Pre-test the EUT in mode 1 to mode 3 in order to find the worst case. Test the EUT in mode 1 as the worst case was found.
----------------	--

7.1.2 Test Setup and Procedure

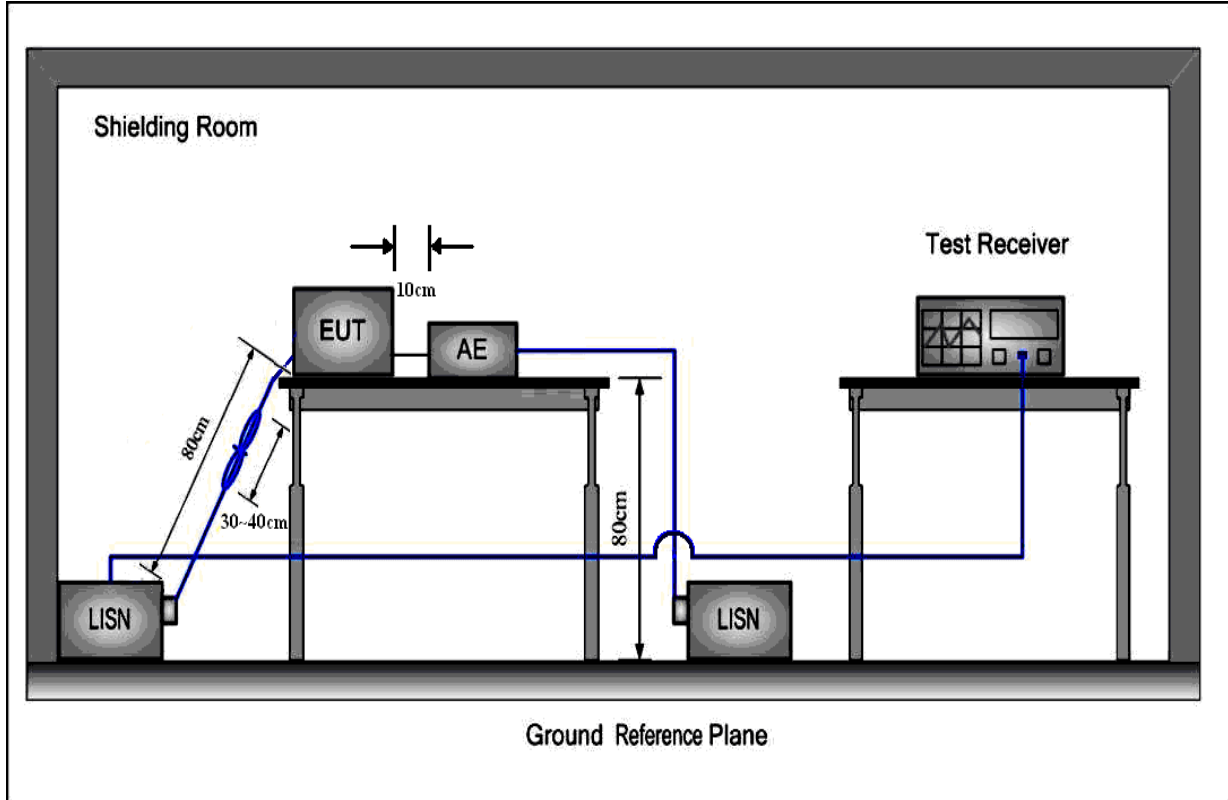

1. The mains terminal disturbance voltage was measured with the EUT in a shielded room.
2. The EUT was connected to AC power source through a LISN 1 (Line Impedance Stabilization Network) which provides a $50\Omega/50\mu\text{H} + 5\Omega$ linear impedance. The power cables of all other units of the EUT was connected to a second LISN, which was bonded to the ground reference plane in the same way as the LISN for the unit being measured. A multiple socket outlet strip was used to connect multiple power cables to a single LISN provided the rating of the LISN was not exceeded.
3. The tabletop EUT was placed upon a non-metallic table 0.8m above the ground reference plane. And for floor-standing arrangement, the EUT was placed on the horizontal ground reference plane, but separated from metallic contact with the ground reference plane by 0.1m of insulation.
4. The test was performed with a vertical ground reference plane. The rear of the EUT shall be 0.4m from the vertical ground reference plane. The vertical ground reference plane was bonded to the horizontal ground reference plane. The LISN was placed 0.8m from the boundary of the unit under test and bonded to a ground reference plane for LISN mounted on top of the ground reference plane. This distance was between the closest points of the LISN and the EUT. The mains lead of EUT excess 0.8m was folded back and forth parallel to the lead so as to form a horizontal bundle with a length between 0.3m and 0.4m. All other units of the EUT and associated equipment was at least 0.8m from the LISN.

7.1.3 Measurement Data

Live Line:

Peak Scan:

Level (dBμV)

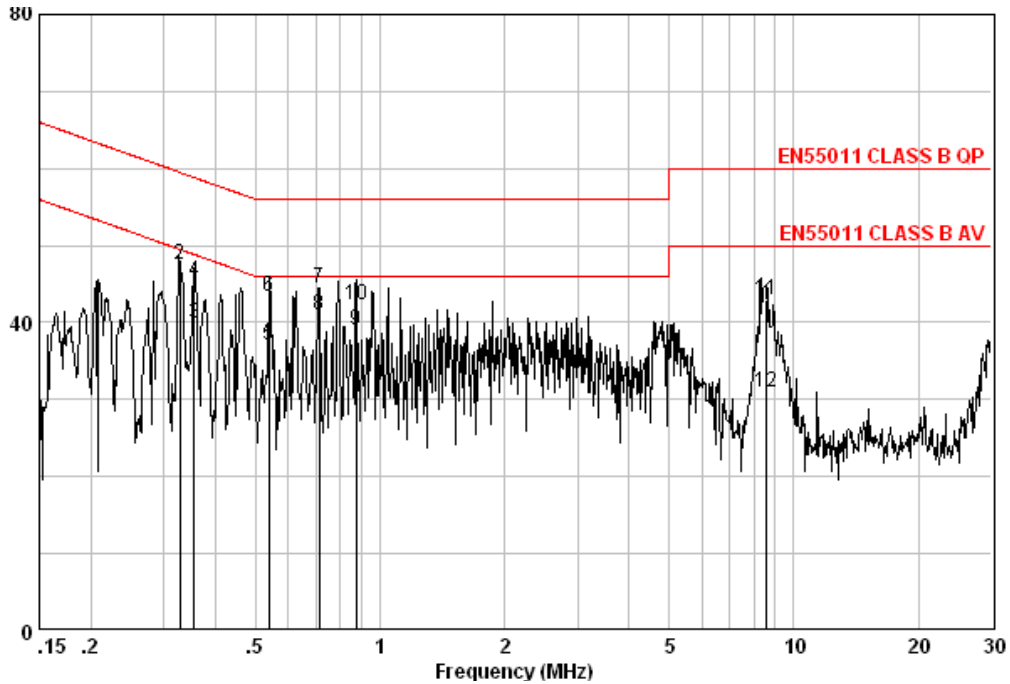

Quasi-peak and Average measurement:

Freq MHz	Read Level dBμV	Cable Loss dB	LISN Factor dB	Level dBμV	Limit Line dBμV	Over Limit dB	Remark
0.329	36.42	0.07	9.63	46.12	49.49	-3.37	AVERAGE
0.329	37.74	0.07	9.63	47.44	59.49	-12.05	QP
0.356	30.13	0.06	9.63	39.82	48.83	-9.01	AVERAGE
0.356	35.76	0.06	9.63	45.45	58.83	-13.38	QP
0.538	27.35	0.05	9.63	37.03	46.00	-8.97	AVERAGE
0.538	33.65	0.05	9.63	43.33	56.00	-12.67	QP
0.712	34.76	0.04	9.63	44.43	56.00	-11.57	QP
0.712	31.36	0.04	9.63	41.03	46.00	-4.97	AVERAGE
0.876	29.32	0.05	9.69	39.06	46.00	-6.94	AVERAGE
0.876	32.68	0.05	9.64	42.37	56.00	-13.63	QP
8.546	33.00	0.17	9.87	43.04	60.00	-16.96	QP
8.546	20.94	0.17	9.87	30.98	50.00	-19.02	AVERAGE

Level = Read Level + LISN Factor + Cable Loss.

Neutral Line

Peak Scan:

Level (dBµV)

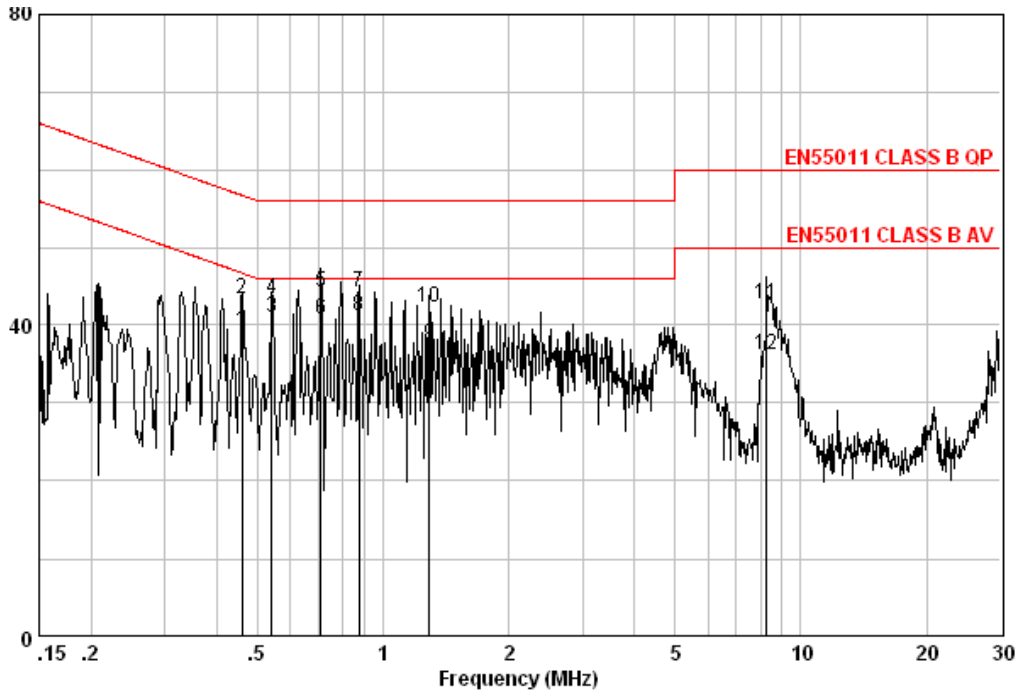

Quasi-peak and Average measurement:

Freq	Read Level	Cable Loss	LISN Factor	Level	Limit Line	Over Limit	Remark
MHz	dBµV	dB	dB	dBµV	dBµV	dB	
0.459	29.45	0.05	9.66	39.16	46.71	-7.56	AVERAGE
0.459	33.67	0.05	9.66	43.38	56.71	-13.34	QP
0.541	31.35	0.05	9.67	41.07	46.00	-4.93	AVERAGE
0.541	33.61	0.05	9.67	43.33	56.00	-12.67	QP
0.708	34.62	0.04	9.68	44.34	56.00	-11.66	QP
0.708	30.99	0.04	9.68	40.71	46.00	-5.29	AVERAGE
0.876	34.60	0.05	9.69	44.34	56.00	-11.66	QP
0.876	31.38	0.05	9.69	41.12	46.00	-4.88	AVERAGE
1.289	27.85	0.03	9.70	37.58	46.00	-8.42	AVERAGE
1.289	32.49	0.03	9.70	42.22	56.00	-13.78	QP
8.279	32.68	0.16	9.89	42.73	60.00	-17.27	QP
8.279	26.21	0.16	9.89	36.26	50.00	-13.74	AVERAGE

Level = Read Level + LISN Factor + Cable Loss.

7.2 Radiated Emissions, 30 MHz to 1 GHz

Test Requirement: EN 55011

Test Method: EN 55011

Test Date: 2012-08-29 (initial test)
2012-09-13 (test after modification)

Test voltage AC 230V 50Hz

Frequency Range: 30 MHz to 1 GHz

Measurement Distance: 10m

Class: Group 1, Class B

Detector: Peak for pre-scan
Quasi-Peak for final measurement

Limit: Table 5 of EN 55011

For 10m

Frequency range	Quasi-peak Limits
MHz	dB (µV/m)
30 to 230	30
230 to 1000	37

On a test site, class B equipment can be measured at a distance of 3m or 10m. An inverse proportionality factor of 20 dB per decade shall be used to normalize the measured data to the specified distance for determining compliance.

At the transition frequency, the more stringent limit shall apply.

7.2.1 E.U.T. Operation

EUT Operation: Mode 1: ultrasonic mode with maximum power.
Mode 2: ultrasonic mode with medium power.
Mode 3: ultrasonic mode with minimum power.
Pre-test the EUT in mode 1 to mode 3 in order to find the worst case.
Test the EUT in mode 1 as the worst case was found.

7.2.2 Test Setup and Procedure

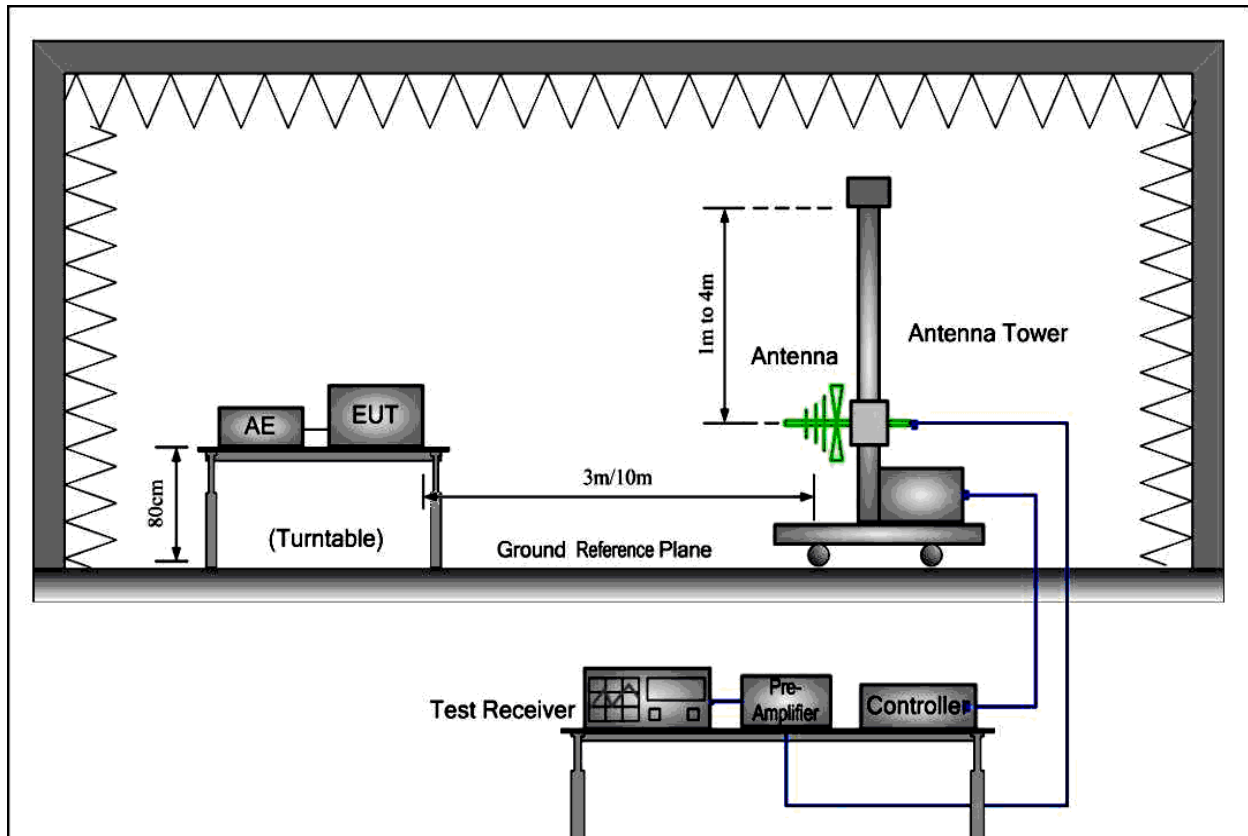

1. The radiated emissions test was conducted in a semi-anechoic chamber.
2. The mains cables shall drape to the ground reference plane.
3. The tabletop EUT was placed upon a non-metallic table 0.8m above the ground reference plane. And for floor-standing arrangement, the EUT was placed on the horizontal ground reference plane, but separated from metallic contact with the ground reference plane by 0.1m of insulation.
4. Before final measurements of radiated emissions, a pre-scan was performed in the spectrum mode with the peak detector to find out the maximum emission spectrum signature data plots of the EUT.
5. The frequencies of maximum emission were determined in the final radiated emissions measurement, The physical arrangement of the test system and associated cabling was varied in order to determine the effect on the EUT's emissions in amplitude, direction and frequency. At each frequency, the EUT was rotated 360°, and the antenna was raised and lowered from 1 to 4 meters in order to determine the maximum disturbance. Measurements were performed for both horizontal and vertical antenna polarization.

7.2.3 Measurement Data

Vertical:

Peak scan

Level (dBμV/m)

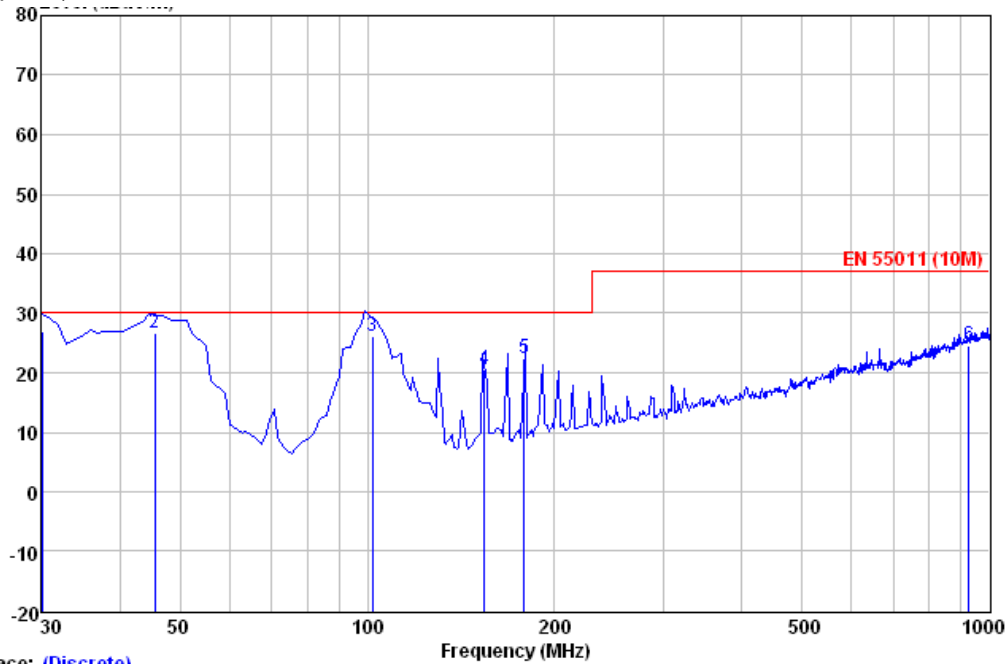

Trace: (Discrete)

Quasi-peak measurement

Freq	Read Level	Antenna Factor	Cable Loss	Preamp Factor	Level	Over Limit	Limit	Remark
MHz	dBμV	dB/m	dB	dB	dBμV/m	dB	dBμV/m	
30.000	44.15	11.48	0.83	29.50	26.96	-3.04	30.00	QP
45.520	42.54	12.66	0.97	29.50	26.67	-3.33	30.00	QP
101.780	42.34	12.11	1.44	29.70	26.19	-3.81	30.00	QP
154.160	40.58	7.92	1.73	29.68	20.55	-9.45	30.00	QP
178.410	40.85	9.24	1.81	29.58	22.32	-7.68	30.00	QP
925.310	26.49	22.04	4.15	28.08	24.60	-12.40	37.00	QP

Level = Read Level + Antenna Factor + Cable Loss – Preamp Factor.

Horizontal:
 Peak scan
 Level (dBμV/m)

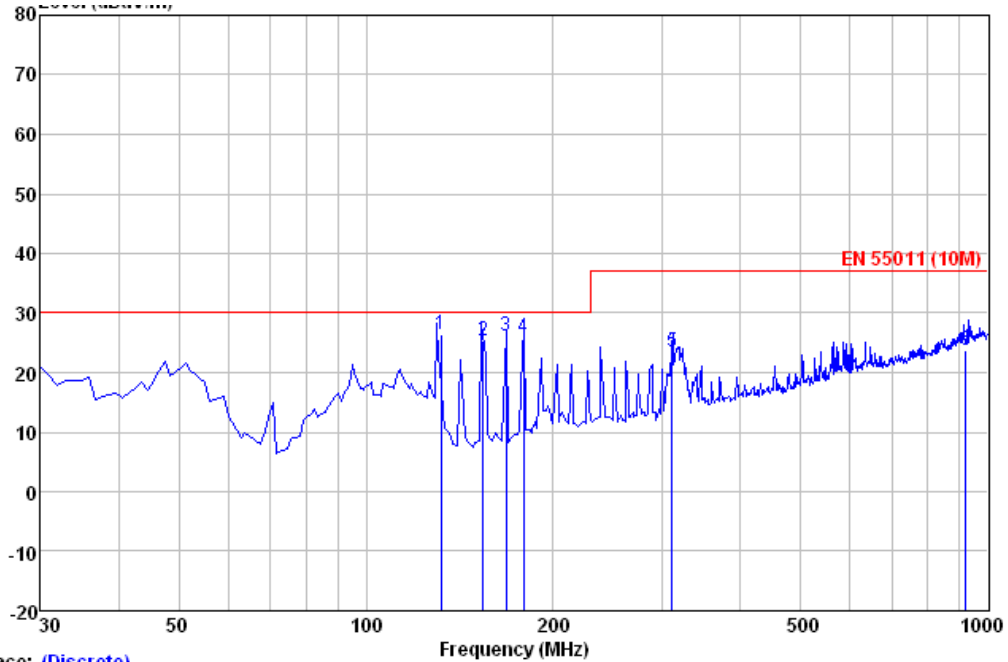

Trace: (Discrete)

Quasi-peak measurement

Freq MHz	Read Level dBuV	Antenna Factor dB/m	Cable Loss dB	Preamp Factor dB	Level dBuV/m	Over Limit dB	Limit Line dBuV/m	Remark
132.010	46.30	8.06	1.62	29.70	26.28	-3.72	30.00	QP
154.160	45.46	7.92	1.73	29.68	25.43	-4.57	30.00	QP
167.740	45.49	8.51	1.78	29.62	26.16	-3.84	30.00	QP
179.380	44.20	9.31	1.82	29.58	25.75	-4.25	30.00	QP
310.330	37.35	13.42	2.39	29.60	23.56	-13.44	37.00	QP
921.430	25.73	22.01	4.15	28.11	23.78	-13.22	37.00	QP

Level = Read Level + Antenna Factor + Cable Loss – Preamp Factor.

7.3 Harmonics Test Result

Test Requirement: EN 61000-3-2
Test Method: See Remark Below
Frequency Range: 100 Hz to 2 kHz

Remark:

Since the EUT was belong to exception of clause 7 and Annex C, according to EN 61000-3-2 figure 1, it was deemed to conform to the requirements of this standard without further testing.

“7 Harmonic current limits

The procedure for applying the limits and assessing the results is shown in Figure 1.

For the following categories of equipment, limits are not specified in this standard:

NOTE 1 Limits may be defined in a future amendment or revision of the standard.

– equipment with a rated power of 75 W or less, other than lighting equipment;

NOTE 2 This value may be reduced from 75 W to 50 W in the future, subject to approval by National Committees at that time.

– professional equipment with a total rated power greater than 1 kW.

– symmetrically controlled heating elements with a rated power less than or equal to 200 W.

– independent dimmers for incandescent lamps with a rated power less than or equal to 1 kW.

NOTE 3 See also C.5.3.”

and

No limit applies for all LED lighting equipments with active input power ≤ 25 W except Discharge lighting equipment (refer to 7.3 b))

Please read clause 7 & Annex C of this standard for reference.

7.4 Flicker Test Result

Test Requirement:	EN 61000-3-3
Test Method:	EN 61000-3-3
Test Date:	2012-08-29
Test Voltage	AC 230V 50Hz
Measurement Time:	10 mins
Class / Severity:	Clause 5 of EN 61000-3-3

7.4.1 E.U.T. Operation

EUT Operation:	Mode 1: ultrasonic mode with maximum power. Mode 2: ultrasonic mode with medium power. Mode 3: ultrasonic mode with minimum power. Pre-test the EUT in mode 1 to mode 3 in order to find the worst case. Test the EUT in mode 1 as the worst case was found.
Note:	“Pst and Plt requirements shall not be applied to voltage changes caused by manual switching. The limits shall not be applied to voltage changes associated with emergency switching or emergency interruptions.” Please also refer to Annex A (Application of limits and type test conditions) for details in EN 61000-3-3. --No limits shall apply to lamps. --Incandescent lamp luminaires with ratings less than or equal to 1 000 W and discharge lamp luminaires with ratings less than or equal to 600 W, are deemed to comply with the dmax limits in this standard and are not required to be tested. --Ballasts are deemed to be part of luminaires and are not required to be tested.

7.4.2 Test Setup and Procedure

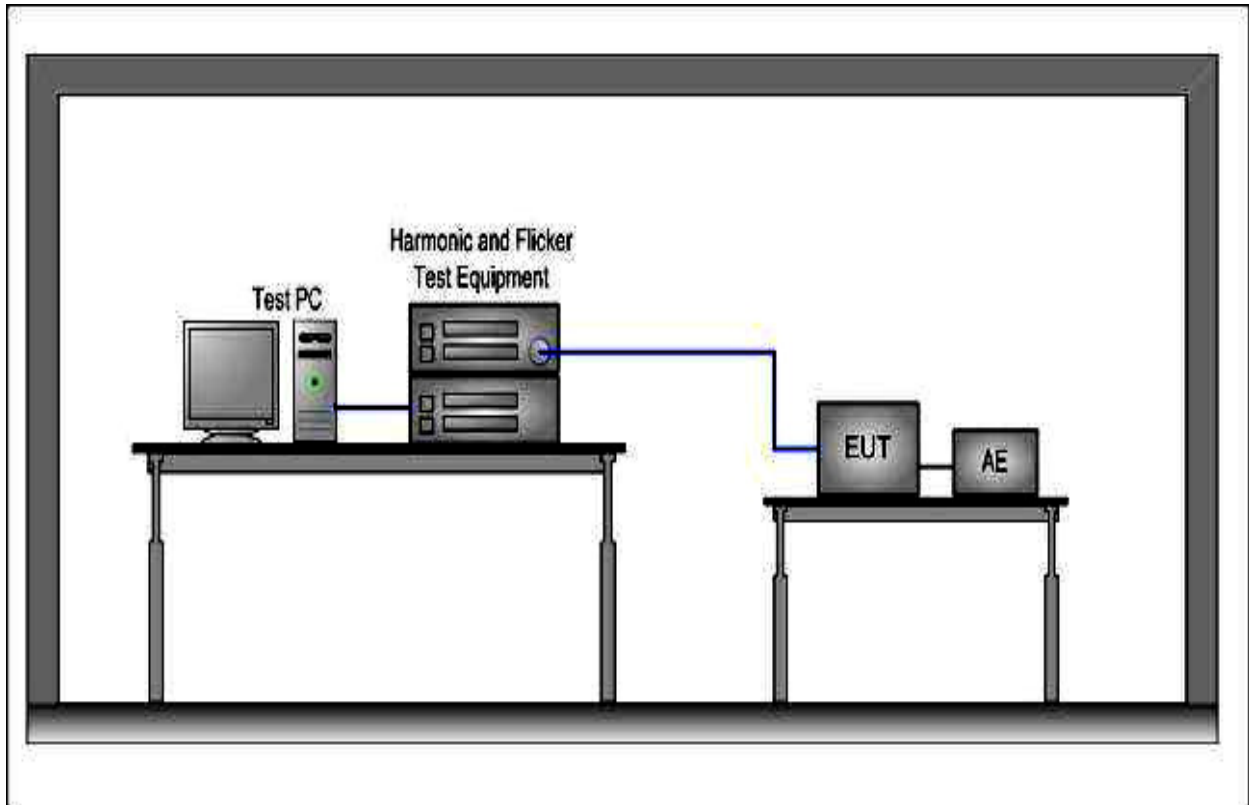

1. The test supply voltage (open-circuit voltage) was the rated voltage of the EUT. The test voltage was maintained within $\pm 2\%$ of the nominal value. The frequency was $50\text{ Hz} \pm 0.5\%$.
2. The voltage fluctuations and flicker were measured at the supply terminals of the EUT.
3. The observation period, T_p , for the assessment of flicker values by flicker measurement, flicker simulation, or analytical method was:
 - for P_{st} , $T_p = 10\text{ min}$.
 - for Plt , $T_p = 2\text{ h}$.

The observation period included that part of the whole operation cycle in which the EUT produces the most unfavourable sequence of voltage changes.

7.4.3 Measurement Data

Flicker Test Summary per EN 61000-3-3 (Run time)

Test Result: Pass

Status: Test Completed

Psti and limit line

European Limits

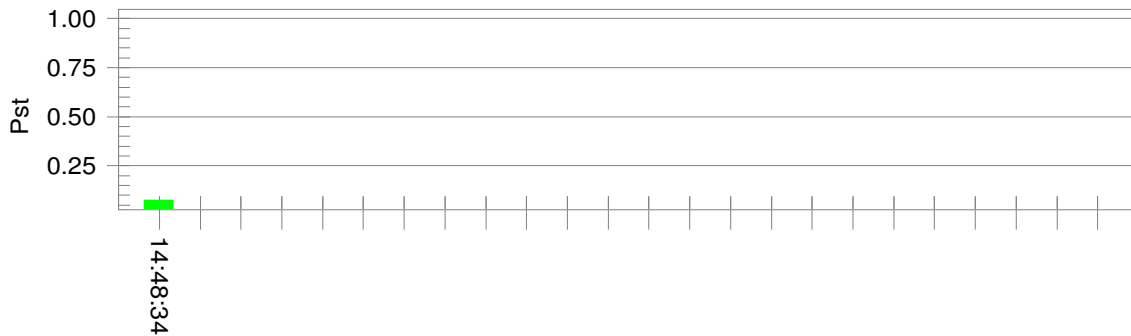

Parameter values recorded during the test:

Vrms at the end of test (Volt):	230.07			
Highest dt (%):	0.20	Test limit (%):	3.30	Pass
Time(mS) > dt:	0.0	Test limit (mS):	500.0	Pass
Highest dc (%):	0.00	Test limit (%):	3.30	Pass
Highest dmax (%):	0.08	Test limit (%):	4.00	Pass
Highest Pst (10 min. period):	0.073	Test limit:	1.000	Pass

8 Electromagnetic Susceptibility Test Results

8.1 Performance Criteria Description in Clause 6 of EN 55014-2

<p>Criterion A:</p>	<p>The apparatus shall continue to operate as intended during the test. No degradation of performance or loss of function is allowed below a performance level (or permissible loss of performance) specified by the manufacturer, when the apparatus is used as intended. If the minimum performance level or the permissible performance loss is not specified by the manufacturer, then either of these may be derived from the product description and documentation, and from what the user may reasonably expect from the apparatus if used as intended.</p>
<p>Criterion B:</p>	<p>The apparatus shall continue to operate as intended after the test. No degradation of performance or loss of function is allowed below a performance level (or permissible loss of performance) specified by the manufacturer, when the apparatus is used as intended. During the test, degradation of performance is allowed, however. No change of actual operating state or stored data is allowed. If the minimum performance level or the permissible performance loss is not specified by the manufacturer, then either of these may be derived from the product description and documentation and from what the user may reasonably expect from the apparatus if used as intended.</p>
<p>Criterion C:</p>	<p>Temporary loss of function is allowed, provided the function is self recoverable or can be restored by the operation of the controls, or by any operation specified in the instructions for use.</p>

8.2 ESD

Test Requirement:	EN 55014-2	
Test Method:	EN 61000-4-2	
Criterion Required:	B	
Test Date:	2012-08-29	
Test voltage	AC 230V 50Hz	
Discharge Impedance:	330 Ω / 150 pF	
Discharge Voltage:	Air Discharge:	8 kV
	Contact Discharge:	4 kV
	VCP/HCP:	4 kV
Polarity:	Positive & Negative	
Number of Discharge:	Minimum 10 times at each test point	
Discharge Mode:	Single Discharge	
Discharge Period:	1 second minimum	

8.2.1 E.U.T. Operation

Operating Environment:

Temperature: 20 °C Humidity: 50 % RH Atmospheric Pressure: 1005 mbar

EUT Operation: Mode 1: ultrasonic mode with maximum power.
 Mode 2: ultrasonic mode with medium power.
 Mode 3: ultrasonic mode with minimum power.
 Mode 4: idle mode.
 Test the EUT in mode 1 to mode 4.

8.2.2 Test Setup and Procedure

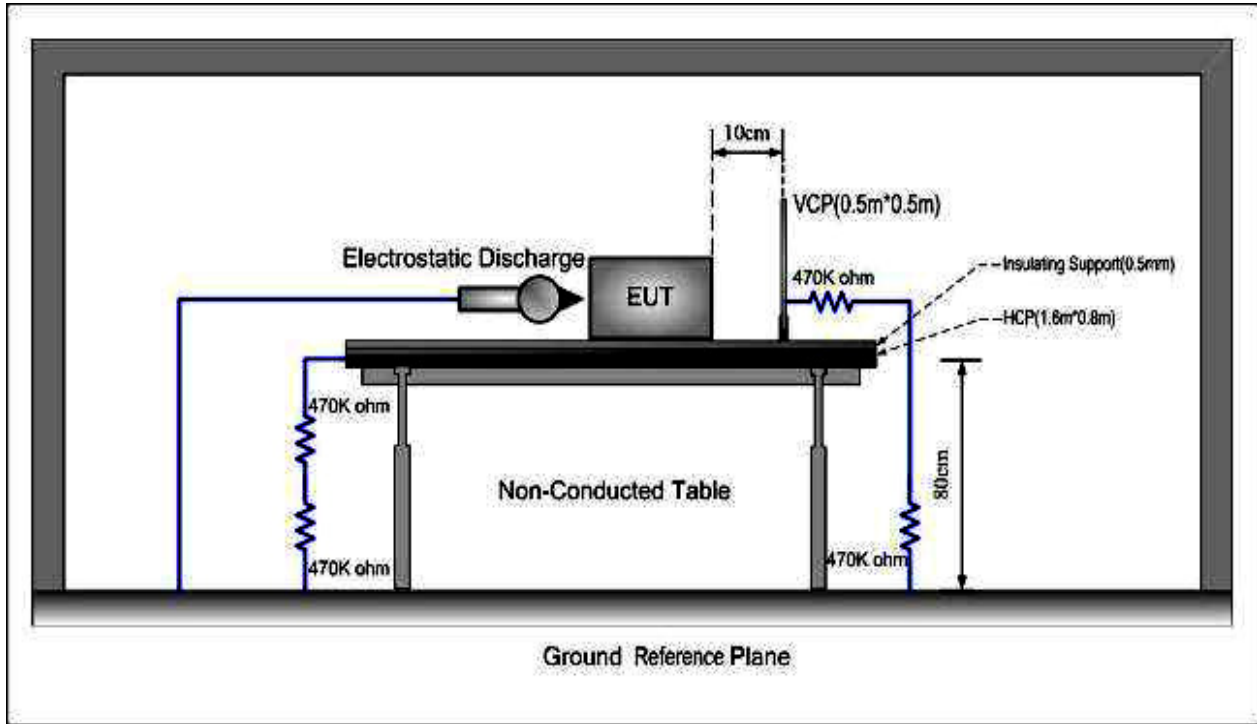

1. Contact discharge was applied only to conductive surfaces of the EUT. Air discharge was applied only to non-conducted surfaces of the EUT.
2. The EUT was put on a 0.8m high wooden table for table-top equipment or 0.1m high for floor standing equipment standing on the ground reference plane (GRP).
3. A horizontal coupling plane(HCP) 1.6m by 0.8m in size was placed on the table, and the EUT with its cables were isolated from the HCP by an insulating support thick than 0.5mm. The VCP 0.5m by 0.5m in size while HCP were constructed from the same material type and thickness as that of the GRP, and connected to the GRP via a 470kΩ resistor at each end. The distance between EUT and any of the other metallic surfaces except the GRP, HCP and VCP was greater than 1m.
4. During the contact discharges, the tip of the discharge electrode touched the EUT before the discharge switch is operated. During the air discharges, the round discharge tip of the discharge electrode was approached as fast as possible to touch the EUT.
5. After each discharge, the ESD generator was removed from the EUT, the generator is then retriggered for a new single discharge. For ungrounded product, a discharge cable with two resistances was used after each discharge to remove remnant electrostatic voltage. 10 times of each polarity single discharge were applied to HCP and VCP.

8.2.3 Test Results

Direct Application Test Results

- Observations: Test Point:
1. All insulated enclosure & seams.
 2. All accessible metal parts of the enclosure.

Direct Application			Test Results	
Discharge Level (kV)	Polarity (+/-)	Test Point	Contact Discharge	Air Discharge
8	+/-	1	N/A	A
4	+/-	2	A	N/A

Indirect Application Test Results

- Observations: Test Point:
1. All sides.

Indirect Application			Test Results	
Discharge Level (kV)	Polarity (+/-)	Test Point	Horizontal Coupling	Vertical Coupling
4	+/-	1	A	A

Results:

- A: No degradation in the performance of the EUT was observed.
- N/A: Not applicable (floor mounted EUT or not requested by Standard).

8.3 Electrical Fast Transients (EFT)

Test Requirement:	EN 55014-2
Test Method:	EN 61000-4-4
Criterion Required:	B
Test Date:	2012-08-31
Test voltage	AC 230V 50Hz
Test Level:	0.5, 1.0 kV on AC
Polarity:	Positive & Negative
Repetition Frequency:	5 kHz
Burst Duration:	300ms
Test Duration:	2 minute per level & polarity

8.3.1 E.U.T. Operation

EUT Operation:	Mode 1: ultrasonic mode with maximum power.
	Mode 2: ultrasonic mode with medium power.
	Mode 3: ultrasonic mode with minimum power.
	Mode 4: idle mode.
	Test the EUT in mode 1 to mode 4.

8.3.2 Test Setup and Procedure

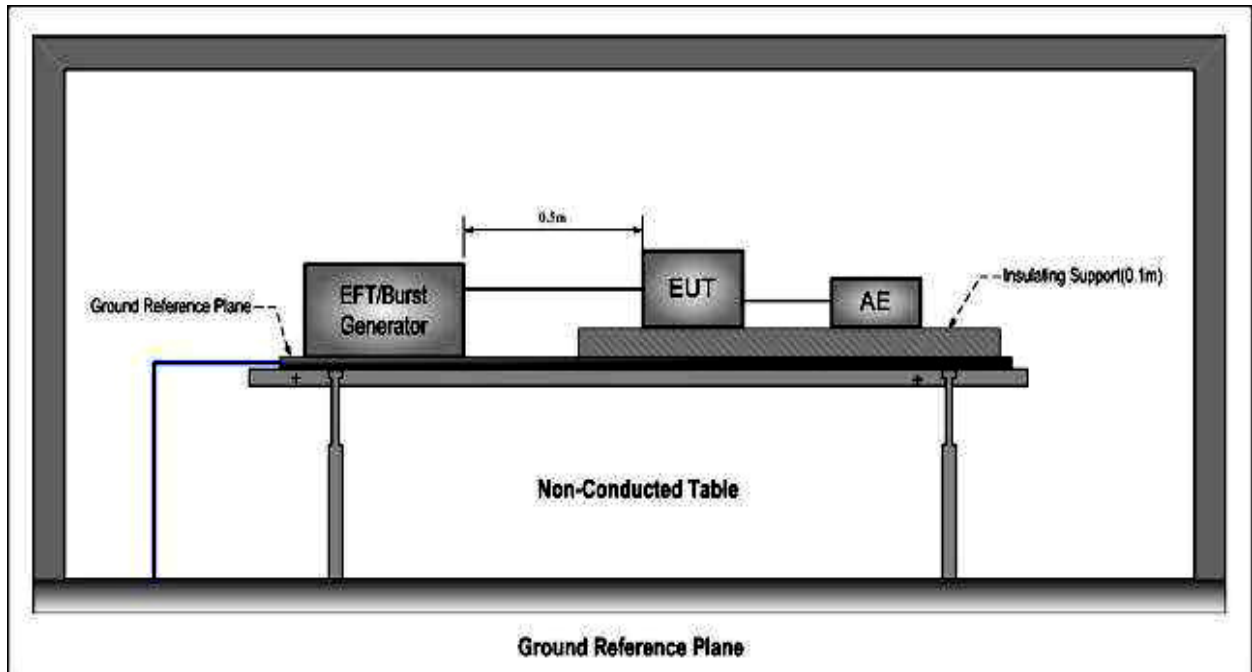

1. The EUT was placed on a ground reference plane (GRP) insulated by an insulating support 0.1m thick and the GRP was placed on a 0.8m high wooden table for table-top equipment. For floor standing equipment, the EUT was placed on a 0.1m high wooden support above the GRP.
2. The GRP shall project beyond the EUT and the clamp by at least 0.1m on all sides. The distance between the EUT and any other of the metallic surface except the GRP was greater than 0.5m. All cables to the EUT was placed on the insulation support 0.1m above GRP. Cables not subject to EFT was routed as far as possible from cable under test to minimize the coupling between the cables.
3. The length of signal and power cable between the EUT and EFT generator was 0.5m. If the cable is a non-detachable supply cable more than 0.5m, the excess length of this cable shall be folded to avoid a flat coil and situated at a distance of 0.1m above the GRP.
4. The EUT was conducted the below specified test voltages for line and neutral or line, neutral and earth simultaneously (for signal line with capacitive coupling clamp), 120 seconds duration. If the equipment contains identical ports, only one was tested; multiconduct or cables, such as a 50-pair telecommunication cable, was tested as a single cable. Cables did not be split or divided into groups of conductors for this test; interface ports, which were intended by the manufacturer to be connected to data cables not longer than 3 m, did not be tested.

8.3.3 Test Results On AC Supply

Lead under Test	Level (±kV)	Coupling Direct/Clamp	EUT operating mode	Observations (Performance Criterion)
Live + Neutral	± 0.5, 1.0	Direct	All modes	(A)

A: No loss of function.

8.4 Surge

Test Requirement:	EN 55014-2
Test Method:	EN 61000-4-5
Criterion Required:	B
Test Date:	2012-08-31 (initial test) 2012-09-14 (test after modification)
Test voltage	AC 230V 50Hz
Test Level:	±1 kV Live to Neutral
Polarity:	Positive & Negative
Generator source impedance:	2Ω
Trigger Mode:	Internal
No. of surges:	5 positive at 90°, 5 negative at 270°.

8.4.1 E.U.T. Operation

EUT Operation:	Mode 1: ultrasonic mode with maximum power. Mode 2: ultrasonic mode with medium power. Mode 3: ultrasonic mode with minimum power. Mode 4: idle mode. Test the EUT in mode 1 to mode 4.
----------------	---

8.4.2 Test Setup and Procedure

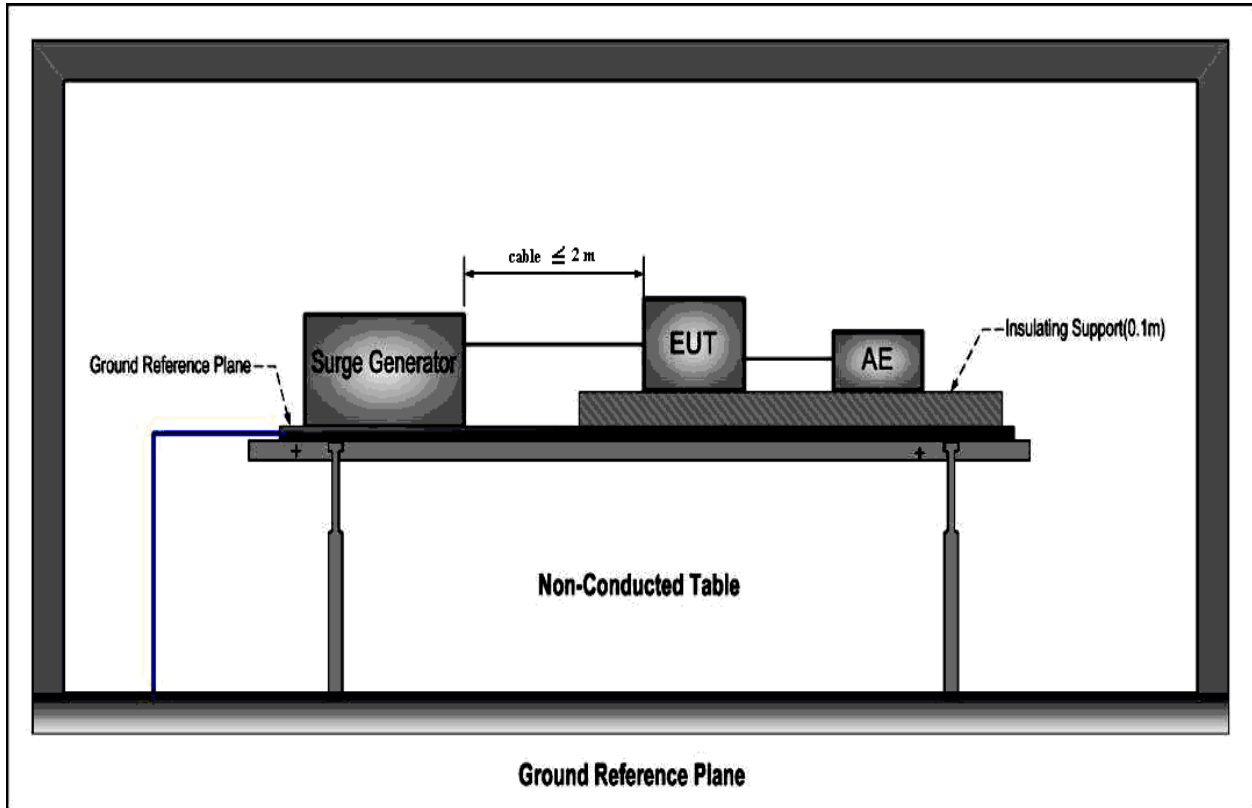

1. The EUT was placed on a ground reference plane(GRP) insulated by an insulating support 0.1m thick and the GRP was placed on a 0.8m high wooden table for table-top equipment. For floor standing equipment, the EUT was placed on a 0.1m high wooden support above the GRP.
2. The 1,2/50 μ s surge was to be applied to the EUT power supply terminals via the capacitive coupling network .Decoupling networks were required in order to avoid possible adverse effects on equipment not under test that may be powered by the same lines and to provide sufficient decoupling impedance to the surge wave so that the specified wave may be applied on the lines under test.
3. The power cord between the EUT and the coupling/decoupling network do not exceed 2m in length. The interconnection line between the EUT and the coupling/ decoupling network shall not exceed 2m in length.
4. The EUT was conducted the below specified test voltages for line to line and line to neutral and line to earth and neutral to earth, five positive pulses at 90° and five negative pulses 270° for a.c. power ports and five positive pulses and five negative surge pulses for d.c. power ports. The test levels were applied on the EUT with a 2 Ω generator source impedance for power supply terminals and 40 Ω output impedance for interconnection lines. The tests were done at repetition rate 1 per minute.

8.4.3 Test Results:

Pulse No	Line-Line	Level (kV)	Surge Interval	Phase (deg)	Observation (Performance Criterion)
1-5	L-N	+1	60s	90°	(A)
6-10	L-N	-1	60s	270°	(A)

A: No loss of function.

8.5 Conducted Immunity 0.15 MHz to 230 MHz

Test Requirement:	EN 55014-2
Test Method:	EN 61000-4-6
Criterion Required:	A
Test Date:	2012-08-31
Test voltage	AC 230V 50Hz
Frequency Range:	0.15 MHz to 230 MHz
Test level:	3V r.m.s on AC Ports (unmodulated emf into 150 Ω)
Modulation:	80%, 1kHz Amplitude Modulation

8.5.1 E.U.T. Operation

EUT Operation:	Mode 1: ultrasonic mode with maximum power. Mode 2: ultrasonic mode with medium power. Mode 3: ultrasonic mode with minimum power. Mode 4: idle mode. Test the EUT in mode 1 to mode 4.
----------------	---

8.5.2 Test Setup and Procedure

For AC port :

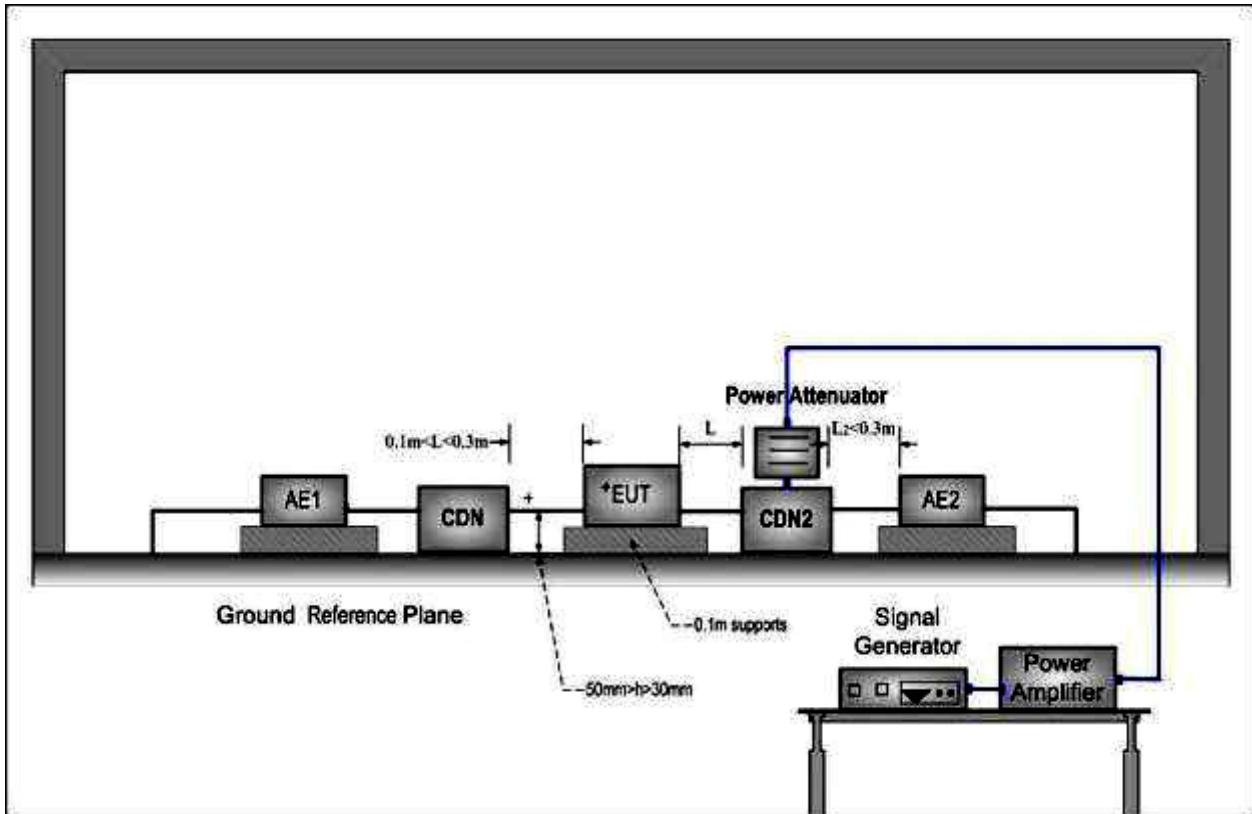

1. The EUT was placed on an insulating support of 0.1m height above a ground reference Plane, arranged and connected to satisfy its functional requirement. All cables exiting the EUT was supported at a height of at least 30 mm above the ground reference plane.
2. The coupling and decoupling devices were required, they were located between 0.1m and 0.3m from the EUT. This distance was to be measured horizontally from the projection of the EUT on to the ground reference plane to the coupling and decoupling device.
3. Each AE, used with clamp injection, shall be placed on an insulating support 0.1m above the ground reference plane. A decoupling network shall be installed on each cable between the EUT and AE except the cable under test. All cables connected to each AE, other than those being connected to the EUT, shall be provided with decoupling networks. The decoupling networks connected to each AE (except those on cables between the EUT and AE) shall be applied no further than 0.3m from the AE. The cable(s) between the AE and the decoupling network (s) or in between the AE and the injection clamp shall not be bundled nor wrapped and shall be kept between 30 mm and 50 mm above the ground reference plane.
4. The frequency range was swept from 150 kHz to 230 MHz, using the signal levels established during the setting process, and with the disturbance signal 80% amplitude modulated with a 1 kHz sine wave, pausing to adjust the RF signal level or to change coupling devices as necessary. Where the frequency was swept incrementally, the step size was not exceed 1% of the preceding frequency value. The dwell time of the amplitude modulated carrier at each frequency was not less than the time necessary for the EUT to be exercised and to respond, and was not less than 0.5 s.

8.5.3 Test Results:

Frequency	Line	Test Level	Modulation	Step Size	Dwell Time	Observation (Performance Criterion)
150 kHz to 230 MHz	2 Wires AC Supply Cable	3V r.m.s	80%, 1 kHz Amp. Mod.	1%	1s	No Loss of Function (A)

8.6 Voltage Dips and Interruptions

Test Requirement:	EN 55014-2
Test Method:	EN 61000-4-11
Criterion Required:	C
Test Date:	2012-08-31
Test voltage	AC 230V 50Hz
Test Level:	0% of U_T (Supply Voltage) for 0.5 Periods 40 % of U_T (Supply Voltage) for 10 Periods 70 % of U_T (Supply Voltage) for 25 Periods
No. of Dips / Interruptions:	3 per Level

8.6.1 E.U.T. Operation

EUT Operation:	Mode 1: ultrasonic mode with maximum power. Mode 2: ultrasonic mode with medium power. Mode 3: ultrasonic mode with minimum power. Mode 4: idle mode. Test the EUT in mode 1 to mode 4.
----------------	---

8.6.2 Test Setup and Procedure

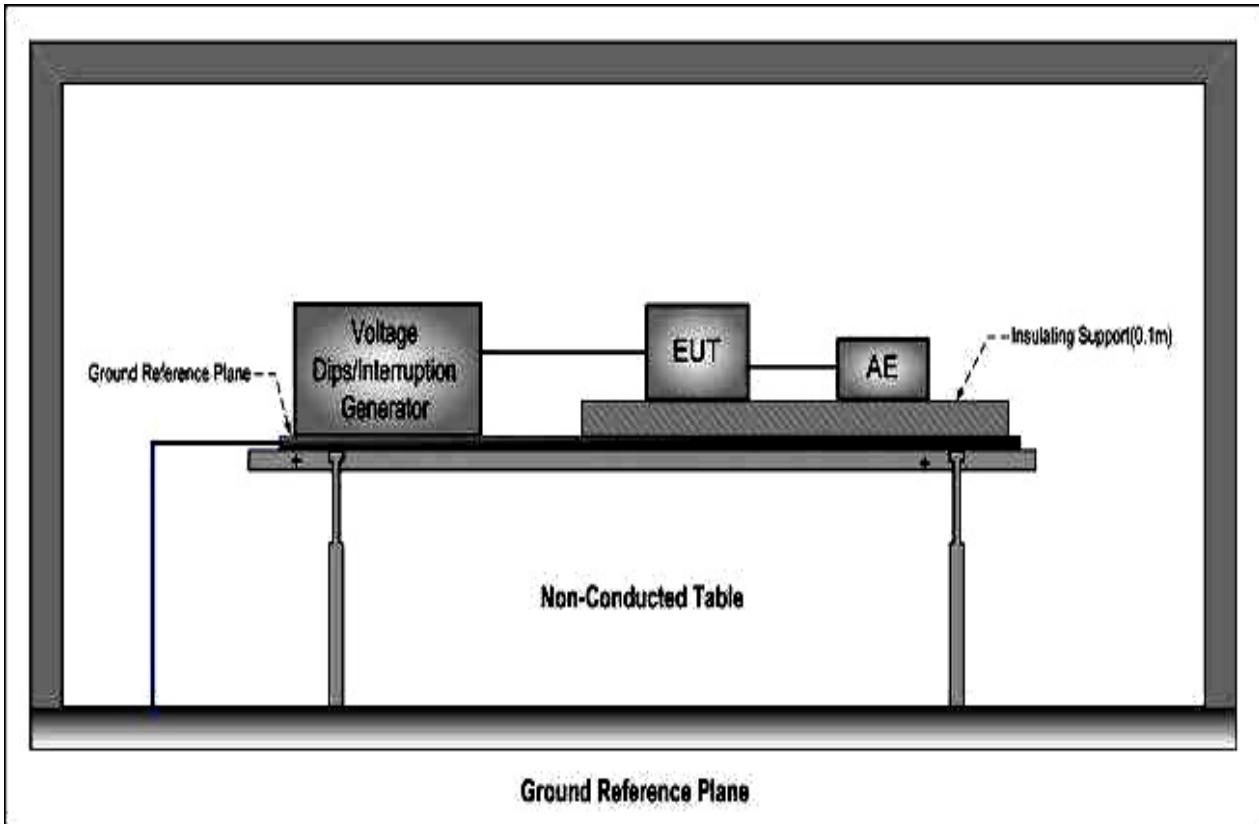

1. The EUT was placed on a ground reference plane (GRP) insulated by an insulating support 0.1m thick and the GRP was placed on a 0.8m high wooden table for table-top equipment. For floor standing equipment, the EUT was placed on a 0.1m high wooden support above the GRP.
2. The test was performed with the EUT connected to the test generator with the shortest power supply cable as specified by the EUT manufacturer.
3. The EUT was tested for each selected combination of test level and duration with a sequence of three dips /interruptions with intervals of 10 s minimum. Each representative mode of operation was tested.
4. For EUT with more than one power cord, each power cord was tested individually.

8.6.3 Test Results

$U_{T=}$ AC 230V 50Hz

Test Level % U_T	Phase	Duration of drop out in Periods	No of drop out	Time between drop out	Observations (Performance Criterion)
0	0°	0.5	3	10s	(A)
40	0°	10	3	10s	(A)
70	0°	25	3	10s	(C)

Remark:

$U_{T=}$ The nominal supply voltage.

A: No Loss of Function.

C: During test the EUT restarted, it could recover by operation after test.

Performance B is within the acceptable criterion for Voltage Dips and Interruption test.

9 Photographs

9.1 Conducted Emissions on Mains Terminals Test Setup

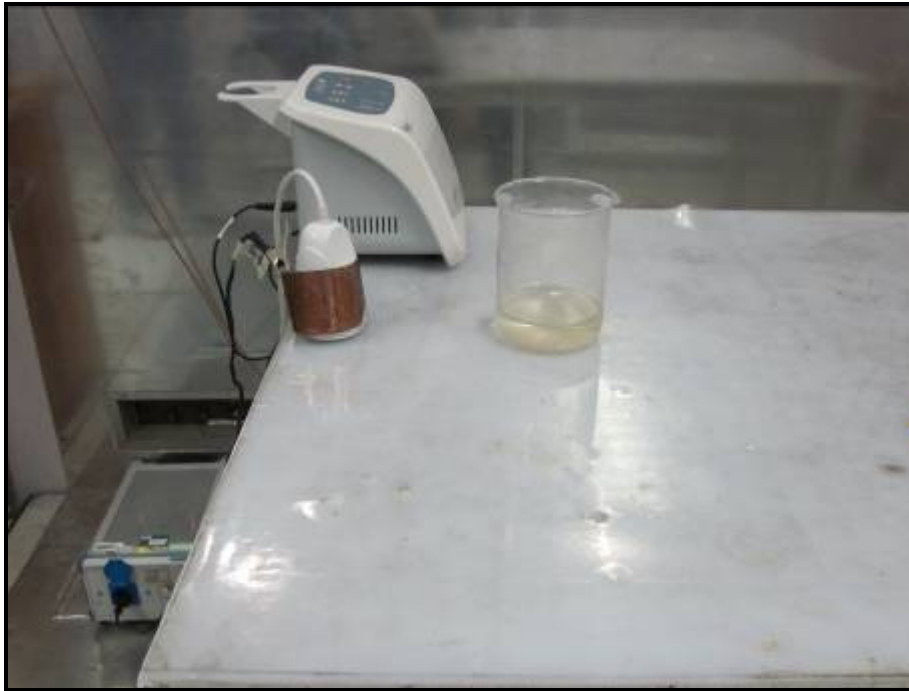

9.2 Radiated Emission Test Setup

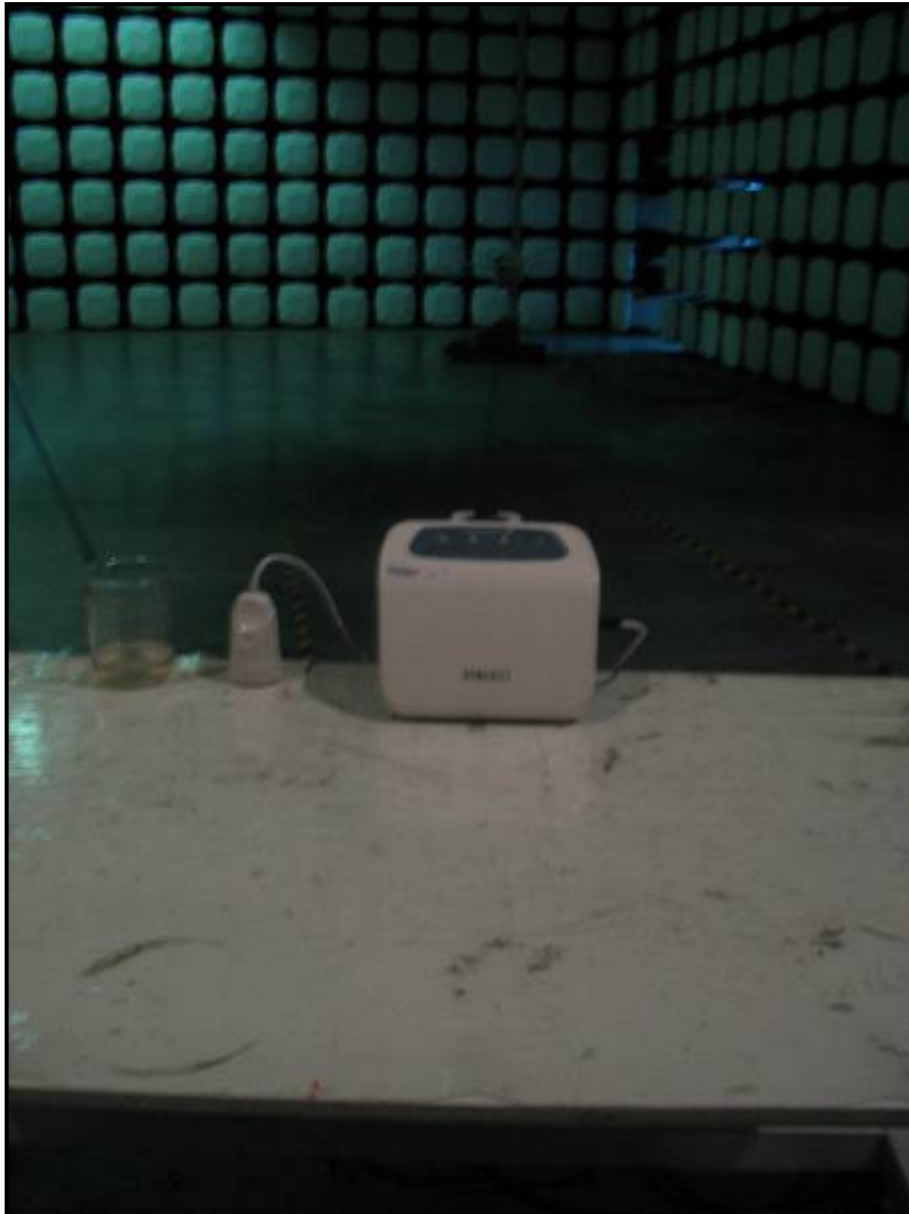

9.3 Flicker Test Setup

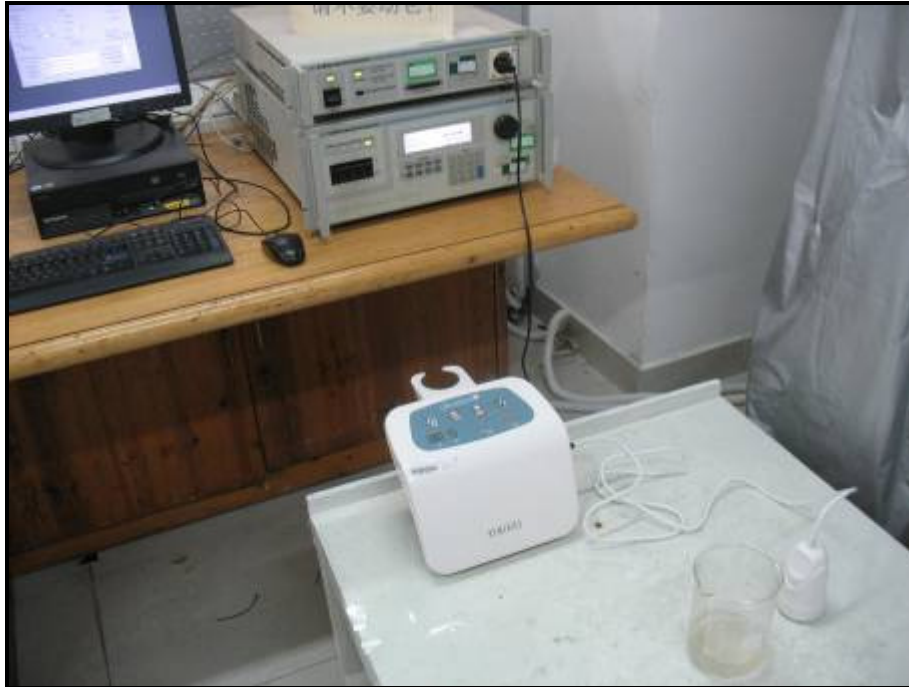

9.4 ESD Test Setup



9.5 EFT, Surge, Voltage Dip and Interruptions Test Setup



9.6 Conducted Immunity Test Setup



9.7 EUT Constructional Details



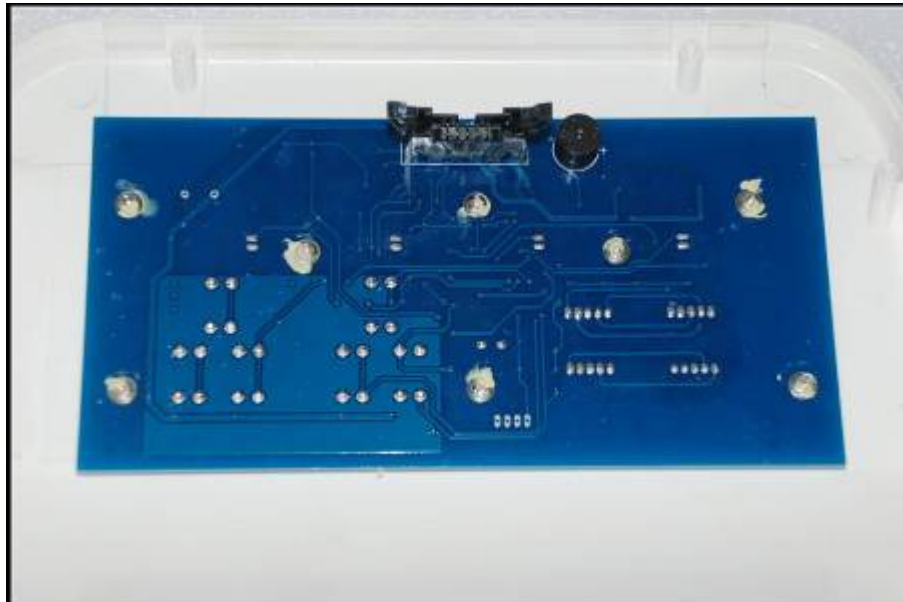
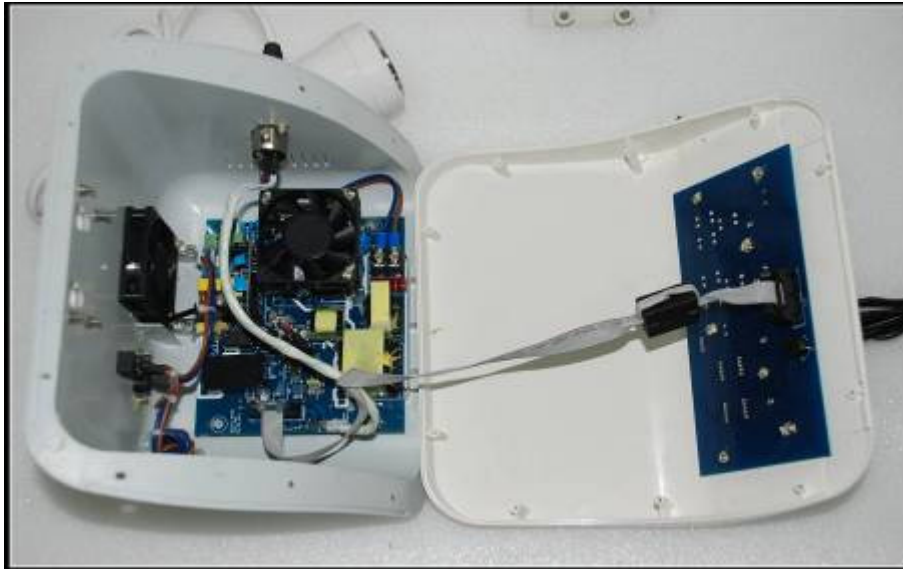

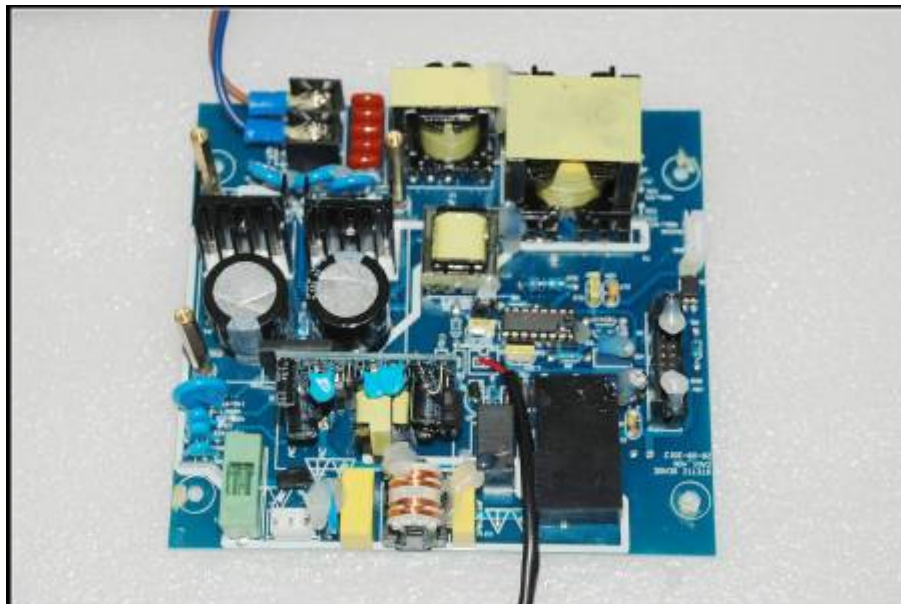
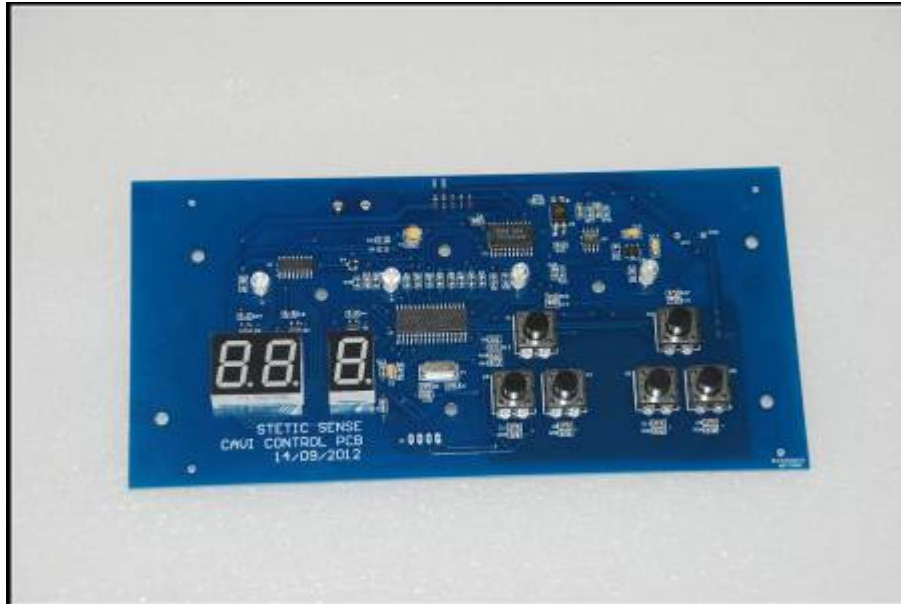

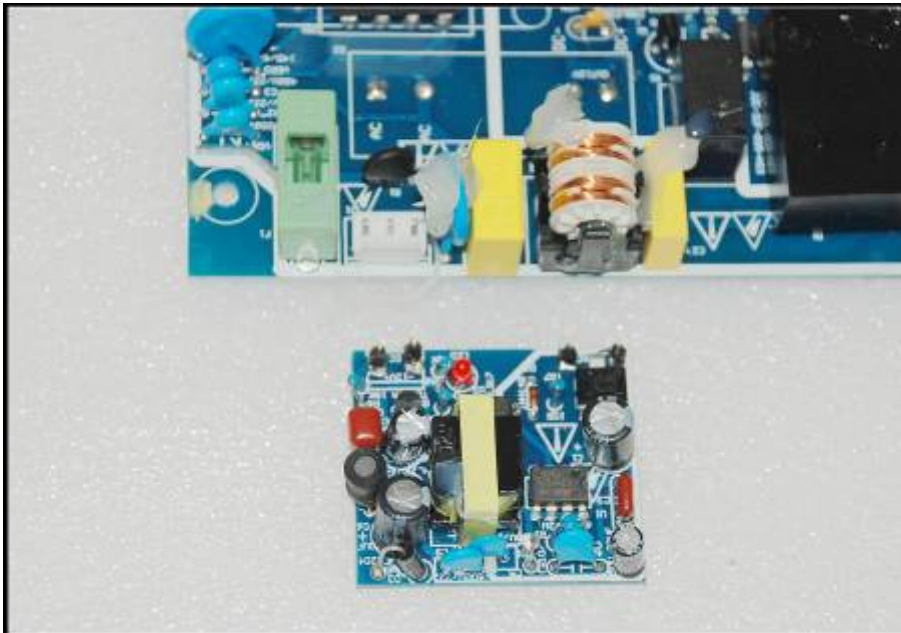
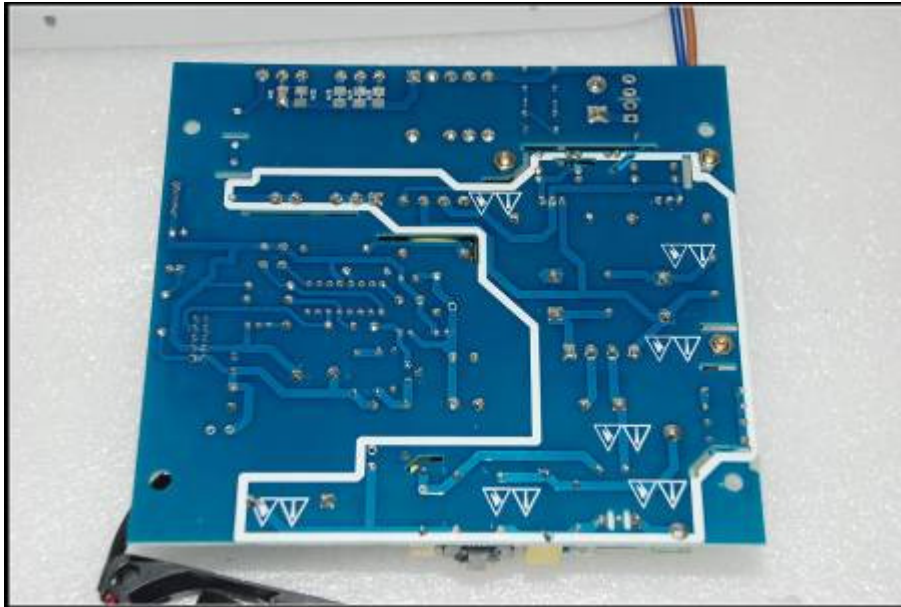

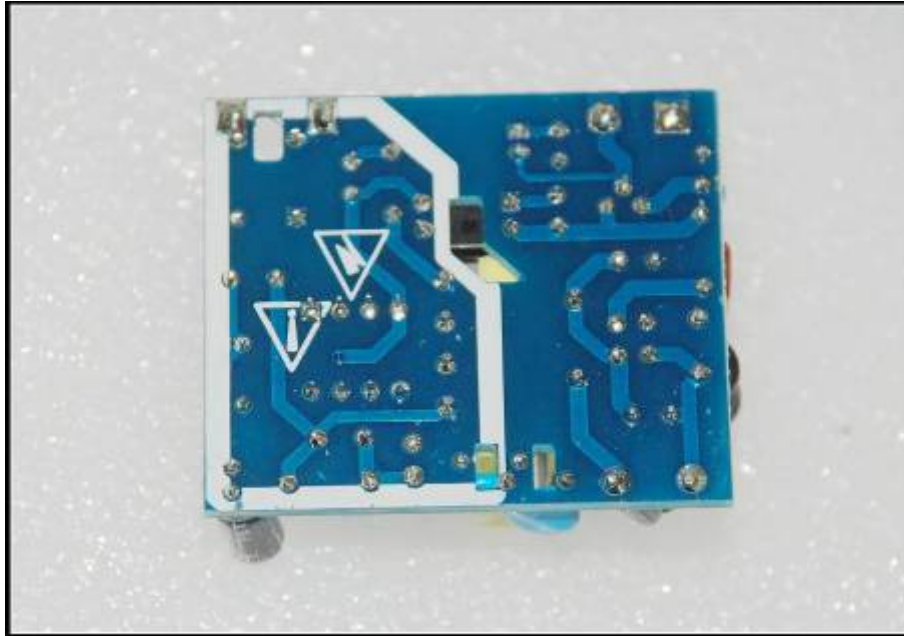

--End of Report--